



WORLD
PRECISION
INSTRUMENTS

INSTRUCTION MANUAL

TBR4100/1025

Free Radical Analyzer

Serial No. _____

www.wpiinc.com

111723

CONTENTS

| | |
|--|----|
| ABOUT THIS MANUAL | 1 |
| INTRODUCTION | 2 |
| Features..... | 2 |
| Notes and Warnings..... | 2 |
| Unpacking..... | 3 |
| INSTRUMENT DESCRIPTION | 4 |
| Instrument Controls..... | 4 |
| Handling 2mm Sensors..... | 7 |
| OPERATING INSTRUCTIONS..... | 10 |
| Setup and Calibration of NO Sensors..... | 10 |
| Setup and Calibration of HPO Sensors | 21 |
| Setup and Calibration of Oxygen Sensors..... | 23 |
| Setup and Calibration of Glucose Sensors..... | 26 |
| Setup and Calibration of CO Sensor | 29 |
| ACCESSORIES..... | 32 |
| SPECIFICATIONS..... | 33 |
| APPENDIX A: REFERENCE TABLES | 35 |
| APPENDIX B: STANDARD SOLUTIONS..... | 39 |
| Standard 1mM H ₂ O ₂ Solution..... | 39 |
| 200mL of 0.1M PBS Buffer Solution..... | 39 |
| 100µM Standard SNAP Solution | 39 |
| APPENDIX C: USING TBR4100/1025 WITH LABSCRIBE..... | 41 |
| Install LabScribe Software..... | 41 |
| Launch LabScribe | 45 |
| Configuring LabScribe for the TBR4100/1025..... | 46 |
| Installing the Drivers Manually..... | 55 |
| INDEX..... | 59 |
| DECLARATION OF CONFORMITY | 61 |
| WARRANTY | 62 |
| Claims and Returns | 62 |

ABOUT THIS MANUAL

The following symbols are used in this guide:



This symbol indicates a CAUTION. Cautions warn against actions that can cause damage to equipment. Please read these carefully.



This symbol indicates a WARNING. Warnings alert you to actions that can cause personal injury or pose a physical threat. Please read these carefully.

NOTES and TIPS contain helpful information.



Fig. 1—TBR4100 front panel



Fig. 2—TBR1025

TBR4100/1025

INTRODUCTION

Free radical analyzers are available in two models:

- TBR4100 is the four-channel model.
- TBR1025 is the one-channel model.

The operation of the analyzers is exactly the same, so they are discussed together in this manual. Specifications of both models are identical. See "Specifications" on page <?>.

TBR4100/1025 is an inherently analog device. In this configuration, the current signal from the sensor enters the device and is converted to a voltage at a user-selectable gain. Thereafter it passes to the current output. WPI recommends that the analog signal then be presented to a Lab-Trax digital recorder where, under user control, software can be used to smooth, filter and calibrate the signal. Lab-Trax is provided with LabScribe software that runs on your computer.

In addition, a pre-calibrated temperature input is also provided. Many sensors are affected by temperature.

Features

- Total galvanic isolation of channel inputs
- Pre-adjusted selectable Poise voltage values for each type of WPI free radical sensor, as well as an adjustable voltage settings
- Front panel mounted digital panel meters to monitor poise voltage and sensor current output on each channel simultaneously
- A temperature monitor input accepting signal from a Pt1000 RTD temperature sensor
- Four selectable sensitivity (input current) ranges
- Front panel BNC output connectors providing a low impedance voltage output signal, suitable for direct connection to any standard data recording device
- Front panel input connectors designed to provide easy connection to the entire line of WPI free radical sensors
- Internal signal filtering to provide rapid signal response while attenuating noise components.
- Universal power supply

Notes and Warnings

NOTE: The TBR4100/1025 incorporates a universal power supply that is internally protected with a fusible link. In the event of a power supply failure, the fusible link will open to disconnect power from the unit. The fusible link is not user serviceable. If the TBR4100/1025 fails to power up, contact WPI Technical Support.

Parts List

After unpacking, verify that there is no visible damage to the sensor. Verify that all items are included:

| TBR1025 | TBR4100 |
|---------------------------------------|---------------------------------------|
| (1) TBR1025 - Free Radical Analyzer | (1) TBR4100 - Free Radical Analyzer |
| (1) Sensor of the buyer's choice | (2) Sensor of the buyer's choice |
| (1) ISO-TEMP-2 - Temperature detector | (1) ISO-TEMP-2 - Temperature detector |
| (2) 2851 - 6' BNC cable | (5) 2851 - 6' BNC cable |
| (1) 91210 - Assembly test resistor 1G | (1) 91210 - Assembly test resistor 1G |
| (1) 91580 - Microsensor cables | (1) 91580 - Microsensor cables |
| (1) Potentiometer adjustment tool | (1) Potentiometer adjustment tool |
| (1) Instruction Manual | (1) Instruction Manual |

Unpacking

Upon receipt of this instrument, make a thorough inspection of the contents and check for possible damage. Missing cartons or obvious damage to cartons should be noted on the delivery receipt before signing. Concealed damage should be reported at once to the carrier and an inspection requested. Please read the section entitled "Claims and Returns" on "Claims and Returns" on page 63 of this manual. Please contact WPI Customer Service if any parts are missing at (941) 371-1003 or customerservice@wpiinc.com.

Returns: Do not return any goods to WPI without obtaining prior approval (RMA # required) and instructions from WPI's Returns Department. Goods returned (unauthorized) by collect freight may be refused. If a return shipment is necessary, use the original container, if possible. If the original container is not available, use a suitable substitute that is rigid and of adequate size. Wrap the instrument in paper or plastic surrounded with at least 100mm (four inches) of shock absorbing material. For further details, please read the section entitled "Claims and Returns" on "Claims and Returns" on page 63 of this manual.

TBR4100/1025

INSTRUMENT DESCRIPTION

The **TBR4100/1025** fulfils two functions. Its LCD display gives you full status of the measurement in progress and the analog output allows an outboard recorder to record the current or voltage with time

Instrument Controls

Channel Modules

The **TBR4100** has four identical channel modules, each with three controls. The **TBR1025** has single channel with the same three controls.

Fig. 3—(Right) TBR4100 channel module

Range Control

The RANGE control is a four-position rotary switch controlling the gain of the channel. Each current marking on the Range control represents the maximum sensor current that can be detected for that setting. Additionally, the range control setting also determines the proportional relationship between the sensor current and the resulting output voltage. The maximum available output voltage for the TBR is 10.0V. The table below provides an example of the sensor current as represented by output voltages of 1, 5 and 10 volts for each of the four range settings.

| Output Voltage | Range Settings | | | |
|----------------|----------------|-------|-------|------|
| | 10nA | 100nA | 0.1µA | 1µA |
| 1.0V | 1nA | 10nA | 0.1µA | 1µA |
| 5.0V | 5nA | 50nA | 0.5µA | 5µA |
| 10.0V | 10nA | 100nA | 1.0µA | 10µA |

Probe Select Control

The PROBE SELECT control is a six-position rotary switch. It sets the applied or “poise” voltage across the sensor. The first five settings on the switch are preset for Nitric Oxide, Hydrogen Sulfide, Hydrogen Peroxide, Glucose and Oxygen. The sixth position is manually adjustable for other sensors whose poise voltage requirements are not met by the first five switch settings. The manual adjustment is accomplished using a small screwdriver and adjusting the front panel trim pot which is available through the access hole on the front panel to the lower right of the Probe Select switch.

Meter Select Control

The meter select control is a two-position toggle switch that changes the value displayed in the channel module's LCD from Applied Voltage to Output Current. The units for Applied Voltage are volts. The units for Output Current are microamps (µA) when the RANGE control is set to 1µA or 10µA and nanoamps (nA) when the RANGE control is set to 10nA or 100nA

Input Connectors

Each channel module has a three-conductor LEMO connector mounted on the front panel near the bottom of each channel module. This connector is compatible with all WPI free radical sensors listed in the table on the next page.

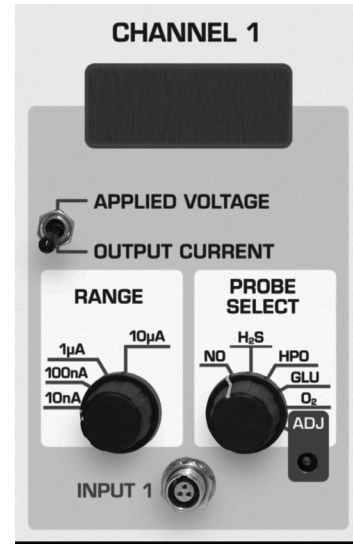

| Macro Sensors | | | | |
|----------------------------|---------|-------------------|----------------|--------------|
| Species | NO | HPO | O ₂ | CO |
| Order Number | ISO-NOP | ISO-HPO-2 | ISO-OXY-2 | ISO-COP-2 |
| Available Diameters | 2 mm | 2 mm | 2 mm | 2 mm |
| Response Time | < 5 sec | < 5 sec | < 10 sec | < 10 sec |
| Detection Limit/Range | 1 nM | < 100nM- 100mM | 0.1%-100% | ~10nM* |
| Sensitivity | 2 pA/nM | 0.02 pA/nM | N/A | ~0.5pA/nM* |
| Drift | None | 0.1pA/min | < 1%/min | None |
| Temperature Dependent | Yes | Yes | Yes | Yes |
| Physiological Interference | None | None | None | Nitric Oxide |
| Replacement Sleeves(4 pk) | #5436 | #600012 | #5378 | #956620 |
| Filling Solution | #7325 | #100042 | #7326 | #95611 |
| Start-up Kit | #5435 | #600011 | #5377 | #95699 |

*Carbon monoxide sensors are not calibrated at the factory because of the toxic nature and inherit dangers of CO.

| Mini Sensors | | | |
|-------------------------------|--------------|-------------------|---|
| Species | Nitric Oxide | Hydrogen Peroxide | Glucose |
| Order Number | ISO-NOPF | ISO-HPO-100 | IGS100 |
| Available Diameters | 100 & 200 µm | 100 µm | 0.6mm coiled |
| Available Length | 2 mm, 4 mm | 2 mm, 4 mm | 1.5mm (Flex body: 35mm) |
| Response Time | < 5 sec | < 5 sec | 100-300sec |
| Detection Limit/Range | 0.2 nM | < 1nM-1mM | 2-25mM |
| Sensitivity | 10pA/nM | 1 pA/nM | 0.5-10nA/mM |
| Drift | none | 1.0 pA/min | none |
| Temperature Dependent | slight | slight | slight |
| Physiological Interference | None | Yes | Acetaminophen, ascorbic acid, uric acid |
| Microsensor Cable | #91580 | #91580 | #91580 |
| Available/w Hypodermic Sheath | ISO-NOPFH | ISO-HPO-100-H | none |
| Available as "L"-shaped | ISO-NOP70L | ISO-HPO-100-L | none |

| Micro Sensors for NO | | | |
|-----------------------------|------------------|-------------------|------------------|
| Order Number | ISO-NOP30 | ISO-NOP007 | ISO-NOPNM |
| Available Diameters | 30 µm | 7 µm | 100 nm |
| Available Length | 0.5 mm, 2 mm | 0.1mm, 2 mm | 0.2 mm |
| Response Time | < 3 sec | < 3 sec | < 3 sec |
| Detection Limit/Range | 1nM | 0.5 nM | 0.5 nM |
| Sensitivity | 1~4pA/nM | 1~4pA/nM | 0.5 pA/nM |
| Drift | none | none | none |
| Temperature Dependent | yes | yes | some |
| Physiological Interference | none | none | none |

TBR4100/1025

Output Module

The output module of the **TBR4100**, to the right of the channel modules, has four BNC connectors that carry the analog output from each of the four input modules. In addition, input and output connections for the Pt1000 temperature sensor are located here.

The **TBR1025** temperature input and output are located on the left side of the unit, and the sensor input and output are located on the right side of the unit.

Fig. 4—(Right) **TBR4100** channel outputs

Rear Panel

The rear panel contains the power entry module and the power switch. The **TBR4100/1025** employs a universal switching supply. It may be connected to any line voltage between 100V and 240V (50/60Hz) with no adjustment.

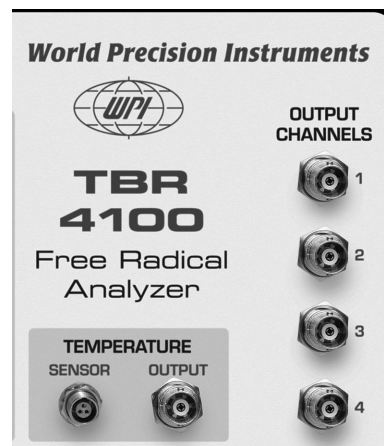

Grounding and Noise Concerns

While the current model of the **TBR4100/1025** is protected against EMI, it may still be necessary to provide additional shielding. Enclosing the system in a Faraday cage is the best way to shield against stray electric fields. Faraday cages can be constructed of copper screening but must be soldered completely along any joining seams. Place all the instruments and the sample into a grounded Faraday cage.

It may not always be possible to put the whole measurement system in a Faraday cage for shielding, as for example with a flow-through system when the probe is immersed into the effluent of a perfusion system or placed directly into the vein or the heart of an animal. In this case, grounding the external bathing fluid, vein, or tissue with a Ag/AgCl reference electrode will often help significantly. If pumps or other electrical instruments are to be used in a flow-through system, the associated equipment or instruments should be grounded as well. Use a common ground for all equipment in the experiment.

After careful grounding and shielding of the electronic equipment and the probe system, sometimes it is found that movement of people in the immediate vicinity causes current fluctuations. These are due to variations in the resulting stray capacitance. There are several ways to minimize these effects. When the measurements are made *in vivo*, it is good practice to ground the animals. In addition, the operator may need to be grounded because large static charges can be generated by the operator's body. Wrist straps connected to ground the operator may be helpful.

Set Up and Use for Current Sensors

In almost all cases, amperometric sensors must equilibrate in the measuring medium. Typically, on immersion, large currents will be observed. These initial currents will move toward zero, rapidly at first then eventually settling to a smaller non-zero value. Expected final currents and approximate settling times are shown in Appendix A, Table 6, page 38. Note that sensors are NOT ready to use or calibrate until observed current values are stable.

Setting Range

In an analog device, gain can be a powerful tool. It literally amplifies small signals up to the point where they can be recorded by chart recorders or data acquisition systems. First stage gain improves signal-to-noise and generally makes recording easier. There is a cost, however. The use of gain narrows the range of observable signal. For example, suppose an amplifier has a baseline noise of 1mV. If a perfectly noiseless sine wave signal with an amplitude of 2mV is presented to the input and the amplifier has a gain of x1, the signal-to-noise ratio will be 2:1. If, however the gain is set to x10 the 2mV signal will be increased to 20mV but the amplifier noise will remain the same. The signal to noise will then improve to 20:1. Higher gains produce even better performance. If this is so, why don't all amplifiers have high gains to get the best noise performance, particularly in the case of free radical sensors whose currents are vanishingly small? The problem occurs with observable range. Amplifiers cannot output a voltage greater than the supply voltage used to power them. Most amplifiers run on $\pm 5V$. In our example above, if we used a gain of x10,000 the output signal would be 20V ($0.002V \times 10,000$). The amplifier, powered by $\pm 5V$, would swing to its maximum voltage of 5V and appear over ranged. The use of gain improves our resolution but narrows our range. In our example above, a gain of 10,000 would limit our observable range to $\pm 0.5mV$.

In the context of recording the output from free radical sensors, a series of gains or ranges are provided. The narrower the range, the higher the signal-to-noise and therefore the quieter the recording. Sensors of this type, however, can produce standing or background current offsets that make use of more sensitive ranges impossible

In most cases free radical sensors will require a period of time to “polarize” or equilibrate. During this settling time, currents can be in the tens of nanoamps and will require a larger and therefore less sensitive range to see the progress. Once the sensor is stable, however, use the most sensitive (smallest) range in which the signal can be seen.

Current ranges of 10 nA ,100 nA, 1 µA and 10 µA are provided by the **TBR4100/1025**.

Filters

The **TBR4100/1025** is internally bandwidth limited at 3Hz. Additional filtration and/or smoothing is available in the recommended **LabScribe** recording software.

Although Filters are generally thought of as devices to remove noise, in reality, they remove signal. Excessive filtration or smoothing can greatly increase the time it takes for signals to reach final value and can even distort faster waveforms and prevent them from reaching their final values.

If you use additional filtration remember that the lower your set filter, the longer your signal will take to reach final value. If you are measuring very small changes in current, you may want to use a lower filter setting to reduce noise. Using a lower filter will make it difficult or impossible to see fast signals. Conversely, if you are trying to see fast changes such as those associated with stop flow or fast kinetic studies, you should use a higher filter setting

Handling 2mm Sensors

The 2mm sensors are similar in construction. These sensors include the **ISO-NOP**, **ISO-HPO-2**, **ISO-OXY-2**, **ISO-H2S-2** and **ISO-COP-2**.

Structure of the Sensor

The basic structure of the sensors is shown below (Fig. 5).

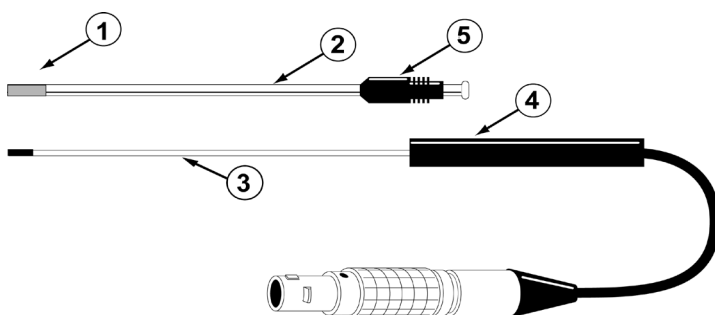

Fig. 5—2mm Sensor assembly

- ① Gas permeable, polymeric membrane covering the end of the stainless sleeve to separate it from the external environment
- ② Disposable, protective stainless steel sleeve that houses the sensitive electrode pair. The sleeve is flanged to properly connect with the locking cap. It must contain fresh electrolyte.
- ③ Unique, internal species-specific sensing pair of working and counter (reference) electrodes
- ④ Probe handle
- ⑤ Locking cap attaches the sleeve to the probe handle

| Sensor | Species | SS Sleeve (4 pack) | Filling Solution | Startup Kit |
|-----------|-------------------|--------------------|------------------|-------------|
| ISO-NOP | Nitric Oxide | 5436 | 7325 | 5435 |
| ISO-HPO-2 | Hydrogen Peroxide | 600012 | 100042 | 600011 |
| ISO-OXY-2 | Oxygen | 5378 | 5326 | 5377 |
| ISO-COP-2 | Carbon Monoxide | 95620 | 95611 | 95699 |

TBR4100/1025

When the sensor is fully assembled (with locking cap and sleeve in place) the internal electrode should press gently against the polymeric membrane, which will be *slightly stretched*. This ensures that the electrolyte diffusion is as thin as possible, minimizing sensor response time.

NOTE: Once a membrane is stretched it is permanently deformed and cannot be reused if the sleeve is removed from the electrode.

The start-up kits include replacement membrane sleeves, along with all the accessories to fill them properly with electrolyte solution.

Durability and Handling

The sensors are relatively durable, except for the membrane sleeve. Exercise caution when handling any sensor to avoid actions that could damage the sensor tip. Pay particular attention to the sensor membrane, because the membrane is extremely delicate and improper handling will lead to damage. With proper care and by following the instructions, a membrane sleeve should last more than one month.

Refer to the Probe Unpacking Instructions that came with your sensor for handling instructions.



CAUTION: Do NOT scratch the sensor membrane sleeve. Do NOT wipe the *sensor membrane* with anything, even Kimwipes. If necessary, squirt it with distilled water or compressed air.



CAUTION: The sensor membrane is easily punctured if it comes into contact with sharp objects. For example, do NOT let the stir bar come into contact with the sensor membrane.

Tip Care

The surface of the sensor tip is very sensitive. The tip of the sensor should never be handled as this will damage the membranes and compromise the electrode's selectivity for a particular species. During use the electrode should be held securely, preferably using a micromanipulator or other similar device that permits accurate positioning, such as WPI's ProGuide electrode holder/positioner (WPI Part #47520, 47510, 47530, 47540).

The electrode should be cleaned periodically in distilled water and dried using soft tissue paper. Organic contamination can be removed using a mild enzymatic detergent such as **ENZOL** (WPI #7363).

Cleaning the Membrane

The membrane sleeve itself requires very little maintenance. The primary concern is to avoid damage to the membrane and to keep it as clean as possible. After each use the membrane should be cleaned by suspending the tip in distilled water for 20-30 minutes to dissolve salts and remove particles which may have accumulated on it. If the probe was used in a protein-rich solution, the tip should first be soaked in a protease solution for several minutes to remove protein build-up, and then in distilled water. Enzymatic detergent (for example, Enzol, WPI#7363) can also be used.

Accumulated organic matter can be removed by briefly immersing the tip in a 0.1M HCl or 0.1M NaOH (at times both may be necessary) for 10 seconds.

A good indication of a dirty membrane sleeve is a sluggish response or an unusually low sensitivity. If these problems are not rectified by cleaning, then the membrane sleeve should be replaced.

The sensors cannot be used in organic solvents.

Sterilizing the Membrane

The membrane sleeves can be sterilized chemically using an appropriate disinfectant (for example, Cidex, WPI#7364).



CAUTION: Do not use alcohol on the sensor.

Replacing the Membrane Sleeve

Even with the best of care and proper maintenance, the membrane sleeve will eventually need to be replaced.

1. Unscrew the locking cap from the handle.
2. Hold the stainless steel sleeve and remove it and the locking cap from the internal electrode assembly, being careful not to bend the internal electrode assembly when doing so.
3. Rinse the internal electrode with distilled water (particularly the tip) and let it soak for at least 15 minutes. Be careful not to let water get up into the handle.
4. Gently dry the electrode with a soft tissue (Kimwipes). Be sure to dry thoroughly the flat surface at the tip of the electrode. After drying the current should stabilize fairly quickly to a low value (for example, 0 - 20pA). If this occurs, it is a good indication that the electrode is functioning properly.
5. If the electrode is not clean, repeat steps 3 and 4.
6. Remove the locking cap from the old used sleeve, and gently slide it onto the new replacement sleeve. Filling a single **2mm** sensor sleeve requires about 1mL of electrolyte.
7. Dip the internal electrode 1-2cm into the electrolyte. The current will rise rapidly offscale. Using the MicroFil™ nonmetallic syringe needle (WPI #MF28G67-5) and 1mL plastic syringe (included in the Startup kit) inject approximately 100µL of electrolyte filling solution directly into the new sleeve, starting about half way down the sleeve and drawing the MicroFil out of the sleeve as it fills. The filling process should be performed slowly enough so as not to create turbulence, which could introduce air bubbles into the electrolyte. The MicroFil (#MF28G67) supplied in the startup kit is less than the length of the sleeve, so that it will not puncture the delicate membrane at the tip of the sleeve during injection.

TIP: If air bubbles form in the electrolyte, gently flick or tap the side of the sleeve to remove the bubbles.

8. Slowly and smoothly insert the electrode into the sleeve, and screw the locking cap into the handle. The electrode should be observed to press gently against the membrane (**Fig. 6**).

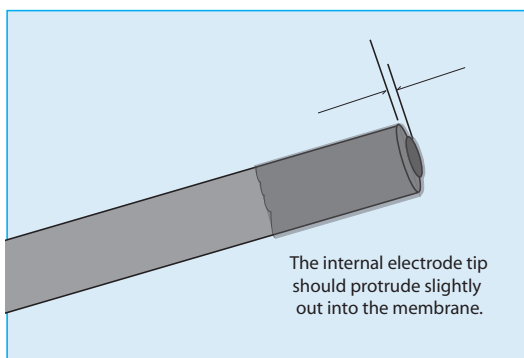

Fig. 6—Membrane placement. The internal electrode tip should protrude slightly out into the membrane.

9. The current displayed on the meter at this time will be high or offscale.
10. Suspend the tip of the newly assembled probe in the calibration solution.
11. After 10-15 minutes the current should no longer be offscale and will gradually decrease with time. It may take several (up to 12) hours for the sensor current to reach a low stable value, at which time it will be ready for use.

TIP: The integrity of the new membrane can be determined by immersing the probe tip into a strong saline solution (1M). If the current increases dramatically or is offscale then the membrane integrity is not good and a new membrane will have to be fitted.

OPERATING INSTRUCTIONS

Setup and Calibration of NO Sensors

Initial Setup

Plug the nitric oxide (NO) sensor into the input connector on the bottom of the required input channel on the **TBR4100/1025**. Set the correct poise voltage for nitric oxide by selecting "NO" on the Applied Voltage Control for the channel you are using. Set appropriate gain. For most sensors or applications, the 10nA range is appropriate. Be sure to give the sensor enough time to polarize before beginning the calibration.

Calibration of the NO Sensor

Accurate measurements of NO require an accurate calibration. Three calibration methods are described in this section.

- The first and most convenient method is based on a simple chemical reaction which generates known amounts of NO (from NO_2^-). This method can only be used with the 2.0mm sensor (WPI #**ISO-NOP**).



CAUTION: This method uses H_2SO_4 (sulfuric acid) and can only be used with the 2mm sensor. Use of this method with solid state (dry) NO sensors will cause irreparable damage.

- The second method is based on the decomposition of the S-nitrosothiol NO-donor (SNAP) using either CuCl as described in Method 1 or CuCl_2 as outlined in Method 2, as a catalyst. The NO liberated from SNAP is used to calibrate the sensor.
- The third method involves preparing aqueous solutions of NO from saturated NO solutions prepared with NO gas.



WARNING: THIS METHOD USES NO GAS WHICH CAN BE FATAL IF IT IS MISHANDLED.

Calibration Kit

Perform the calibration using the NO calibration kit (WPI catalog #**5435**) which consists of the following items:

Plastic stand with two holes, two glass vials, two silicon septums without holes, two silicon septums with holes and radial slit, one short needle, one long needle.

The chemicals required for the calibration are not provided.

NOTE: The NO chamber (WPI#**NOCHM**) can be used as an alternative to the use of the calibration kit. Designed specifically for use with 2.0mm electrodes, the chamber can be adapted to other probes. Calibration temperatures from 4 - 40°C can be controlled using an external circulating bath.

Calibration by Chemical Generation of NO

Type of NO sensor that can be calibrated with this method: ISO-NOP

This method is recommended for use ONLY with the 2.0mm sensor (WPI #**ISO-NOP**).

The first step is to prepare the following two solutions:

Solution #1: 0.1M H_2SO_4 + 0.1 M KI

To make 500mL of solution requires:

4.9g of H_2SO_4 (2.7mL of concentrated H_2SO_4 {18.4 M})

8.3g of KI

Slowly add the sulfuric acid to about 400mL of distilled water while stirring. Then add the KI and mix; finally add distilled water to a final volume of 500mL.

Solution #2: 50 μ M KNO₂ (or NaNO₂)

The recommended method for preparing this solution is to purchase an ion chromatography liquid nitrite standard (NaNO₂ or KNO₂) which may be diluted as appropriate. Standard Nitrite is available from WPI (#7357).

Alternatively, crystalline reagent KNO₂ may be used, but you should note that KNO₂ is extremely hygroscopic and degrades once exposed to atmospheric moisture. It is therefore recommended that if the crystalline reagent is to be used that the reagent packaged under argon be purchased (available from Eastman Kodak Chem #105 7462), and that it be stored in a desiccator. While this will extend the life of the reagent, it will need to be replaced more frequently than will the liquid standard. The standard nitrite solution prepared from this compound should be stored in a gas-tight bottle and refrigerated.

This method of calibration is based on the following reaction:

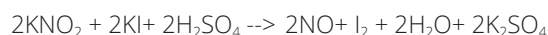

where a known amount of KNO₂ is added to produce a known amount of NO. The quantity (and so the concentration) of NO generated can be calculated directly from the stoichiometry if the concentrations of the reactants are known. Since KI and H₂SO₄ are present in great excess the limiting reagent is KNO₂. Experiments have demonstrated that the nitric oxide generated from this reaction will persist sufficiently long to calibrate the NO sensor easily and accurately. Since the reaction goes to completion, the equation above states that the ratio between KNO₂ and NO is 1:1. Therefore the amount of NO generated in the solution will be equal to the amount of KNO₂ added. The final concentration of NO will be equal to the diluted concentration of KNO₂ in the solution.

Calibration Procedure

1. Allow the sensor to polarize according to the times shown in Appendix A, Table 6, page 38.
2. Record the value of the sensor current before removing it from the distilled water in which the tip has been immersed during storage.
3. Immerse the ISO-NOP sensor tip in a strong saline solution (1M), and after waiting a few minutes for the current to stabilize record its value. If the current is offscale or unstable after several minutes in solution, it is likely that the membrane has been damaged and the sleeve needs to be changed (refer to the section on "Replacing the Membrane Sleeve" on page 9).
4. Place a magnetic stirring bar into one of the glass vials included in the calibration kit. Pipette an appropriate volume (for example, 10mL) of solution #1 into the vial. This volume will be used later in the calculation of the final concentration of NO in solution.
5. Allow the sensor to polarize until the current reaches a steady baseline value. This may take up to 12 hours. The baseline current should settle somewhere between 1000-8000 pA on average. If the value exceeds 8000pA, see "Replacing a Membrane Sleeve," page 28.

Note: The calibration should be carried out at the same temperature at which the experimental measurements of NO are to be made. This can be accomplished by placing the vial and stand in a water bath at the appropriate temperature, and allowing the temperature of the solution in the bottle to equilibrate with the water bath.

6. Place the stand (and water bath, if appropriate) on the magnetic stirrer, and turn on the stirrer so that the bar is stirring at a moderate rate. **This rate should not be modified once it is set.**
7. Secure the ISO-NOP sensor in an electrode holder such as WPI's Pro-Guide or a micromanipulator (or use one of the septa included with the start-up kit). Do not push the sensor tip through the hole — slide the electrode laterally through the sliced side of the septum. Carefully lower the sensor into the vial sealing the opening with the septum. The sensor tip should be immersed about 2-3 mm into the solution, and should not be in contact with stir bar. Be very careful when inserting the sensor not to make contact between the cap and/or bottom of the jar with the tip of the sensor, because this could damage the membrane.

TBR4100/1025

8. Wait until the current on the display becomes stable again before continuing. This may take several minutes if the sensor has undergone a large temperature change.
9. If you feel it necessary to de-gas Solution #1 prior to calibration, this can be done by inserting one of the long stainless steel needles included with the calibration kit through the septum so that the tip is in the solution. Attach the needle through appropriate tubing to a source of pure argon gas (nitrogen may also be used). Insert one of the short needles included with the kit through the septum such that the needle tip is clearly exposed (not in the solution) inside the vial. The small needle allows gas to escape, thereby avoiding a buildup of pressure. Purge the solution at low pressure (5PSI or less) for 15 minutes.
10. Once purging is complete and the gas source is turned off, remove the purging and pressure relief needles.
11. Allow a few minutes for the temperature to equilibrate with the water bath again since purging with the gas may have changed the temperature.
12. Once a stable baseline is re-established, record the value. The quiescent baseline current is an indicator of the health of the sensor.
13. Generally, it is not necessary to pre-purge the calibration solution, since the NO decays only very slowly in this solution.

Creating a Calibration Curve

To create a calibration curve, measure the difference in current (pA) generated by the addition of known quantities of KNO_2 to the calibration solution. Typically, quantities are added in succession, and each quantity is twice the amount of the previous addition. A standard protocol might include four successive additions of KNO_2 . For example, 5nM, 10nM, 20nM, 40nM.

Once the baseline has been set to zero, generate a known concentration of NO in the solution by adding a known volume of a the NO standard (solution #2). For example:

Addition 1:

Add 50 μL of solution #2 to 10mL of solution #1. Then the amount of NO produced can be calculated by simple dilution factors, as follows:

50 μL of 50 μM KNO_2 (solution #2) into 10mL solution #1 = 1:201 dilution. Hence, amount of NO produced = $50 (\mu\text{M}) \div 201 = 0.2487\mu\text{M} = 249\text{nM}$.

Addition 2:

- 100 μL of solution #2 added to the above solution will produce 493nM NO (for example, dilution factor = 1:101.5).
- The output from the **TBR4100/1025** will look similar to the example shown in **Fig. 5**. Here three sequential additions of KNO_2 have been made to solution #1.
- From this output a calibration curve can then be created by plotting the changes in current (pA) against the changes in concentration (nM). The slope of this curve indicates the sensitivity of the probe.
- Once the sensitivity of the probe has been ascertained (in the above example the sensitivity was 1.557pA/nM) the sensor is ready to use experimentally.

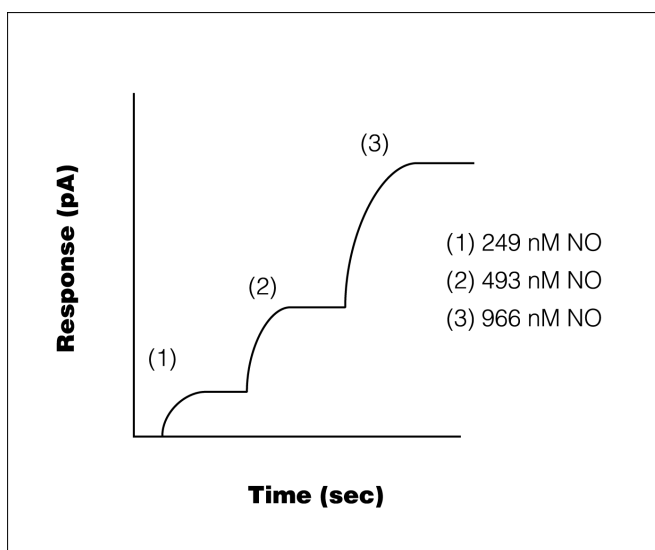

Fig. 7—Calibration Curve

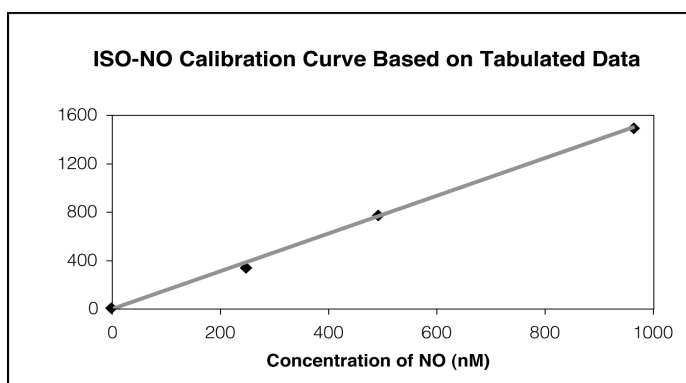

Fig. 8—Calibration Output

| [NO] nM | Response (pA) |
|---------|---------------|
| 0 | 0 |
| 249 | 332 |
| 493 | 746 |
| 966 | 1486 |

Calibration of NO Sensor by Decomposition of SNAP

This method can be used to calibrate all NO sensors (see Zhang, *et al.*, "Novel Calibration Method for Nitric Oxide Microsensors by Stoichiometrical Generation of Nitric Oxide from SNAP" *Electroanalysis*, 2000, 12: 6).

S-nitroso-N-acetyl -D,L-penicillamine (SNAP) is a stable NO-containing compound that can be used for quantitative generation of NO in solution. SNAP decomposes to NO and a disulfide byproduct when dissolved in water. However, the rate of decomposition of SNAP is very slow. The kinetics controlling the decomposition of SNAP depend on several parameters including pH, presence of catalyst, temperature and light.

In the procedure described here, SNAP is used in combination with a catalyst to generate known amounts NO in solution which can then be used to accurately calibrate various NO sensors. The protocol does not investigate all parameters involved in SNAP decomposition, nor is it intended to propose a model by which SNAP is decomposed.

Two methods are described here for the calibration of NO sensors based on decomposition of SNAP. The first method relies on the use of CuCl (cuprous chloride) as a catalyst for the 100% conversion of SNAP into NO. This method is extremely accurate but technically more demanding than the second method, which relies on the use of CuCl₂ (cupric chloride) for the partial but quantifiable conversion of SNAP to NO.

Method 1: Calibration by Decomposition of a S-nitrosothiol Compound Using CuCl as a Catalyst

This method of calibration results in the 100% conversion of SNAP to NO. The amount of NO produced, therefore, is based on the final concentration of SNAP.

! CAUTION: The described calibration procedure requires the use of cuprous (I) chloride, CuCl, where CuCl is the active catalyst for the conversion of SNAP to NO. The calibration curve assumes only the presence of CuCl and hence a 100% conversion efficiency of SNAP to NO (see "A novel method to calibrate nitric oxide microsensors by stoichiometrical generation of nitric oxide from SNAP", X. Zhang, et. al., Electroanalysis, 2000, 12(6),425-428). However, in the presence of oxygen CuCl is readily oxidized to CuCl₂. This will happen naturally if the compound is exposed to air and/or there is inadequate storage of CuCl. The oxidation product CuCl₂ is much less efficient at catalyzing the conversion of SNAP to NO, and this would appear during calibration as an apparent low sensitivity of the electrode to NO.

Since CuCl is readily oxidized to CuCl₂ special precautions must be taken to keep it in its reduced state prior to any calibration. It is recommended that CuCl be stored under inert conditions and if used in solution then the solution must be degassed with inert gas and absent of all oxygen.

NOTE: If your laboratory is not adequately equipped to satisfy the conditions for storage and use of CuCl please refer to the Method 2, page 18, which describes a similar calibration procedure based on the use of cupric (II) chloride CuCl₂, in which CuCl₂ is the active catalyst for the conversion of SNAP to NO.

Getting Started

Prepare the following solutions:

#1—Saturated solution of cuprous chloride: This should be prepared by adding 150mg CuCl to 500mL distilled deoxygenated water. The distilled water can be deoxygenated by purging with pure nitrogen or argon gas for 15 min. The saturated CuCl solution will have a concentration of approximately 2.4mM at room temperature and should be kept in the dark prior to use.

#2—Standard SNAP solution: To prepare the standard solution of SNAP, weigh approximately 5.0mg +/- 2.0mg of SNAP and add it to solution #1. Calculate the molarity of SNAP solution. Decomposition of SNAP in the stock solution proceeds very slowly due to the presence of chelating reagent, EDTA. Thus the rate of decomposition is negligible and the stock solution of SNAP remains relatively stable for at least 5 hours if kept in refrigerator.

NOTE: The purity of standard reagent, SNAP, is very important for the reported data. Use high grade SNAP with purity of 95% or better. SNAP can be purchased from WPI (#SNAP25, SNAP50, SNAP100).

| Quantity | WPI Part # |
|-------------|------------|
| 25 mg vial | SNAP25 |
| 50 mg vial | SNAP50 |
| 100 mg vial | SNAP100 |

TIP: For complete instructions on making standard 100µM SNAP and calculating the molarity of SNAP solution, see Appendix B, page 39.

Calibration Procedure

Within a nitrogen or argon environment, place 10.0mL of solution #1 (CuCl) in a 20mL vial (supplied in the ISO-NOP calibration kit). Drop a small stirring bar into the solution, and place the vial on a magnetic stirring plate. Immerse a NO probe into this solution and, while stirring, allow the sensor to polarize until the background current stabilizes. Minimal drift is normally in 3-5 minutes, although expected baseline current values are different for each sensor. See the (Appendix A, Table 6, page 38.) As soon as the background current as observed on the **TBR4100/1025** meter becomes stable you can begin to record the current output on the Lab-Trax or other data system.

Next, inject 3 aliquots containing 5 μ L, 10 μ L and 20 μ L sequentially of the SNAP stock solution (solution #2) into the vial containing cuprous chloride solution. Depending on the required calibration range (for example, the final amount of NO produced) desired, the volumes of SNAP stock solution could be increased to produce a greater concentration of NO. It is recommended that calibration range be kept close to the anticipated experimental concentration of NO.

Immediately following the first addition of SNAP into Solution#1 the current (pA) output from the ISO-NO will be seen to increase rapidly. Within a few seconds the response will reach a plateau and the second aliquot of SNAP can then be added. Successive additions of the remaining aliquots of SNAP can be made in a similar way.

A calibration curve can be constructed by plotting the signal output (pA) vs. concentration (nM) of SNAP. Each addition of SNAP corresponds to equivalent NO concentration. The response should be very linear from 10 to 1000nM. The sensitivity of the NO probe can be established from the gradient or slope of the response curve. The sensitivity of the ISO-NOP sensor is about 1pA/nM. After the sensitivity of the NO probe is established, the LabScribe software can be programmed to display data in either concentration directly (for example, nM, mM) or redox current (for example, pA, nA).

NOTE: Remember that most NO probes are sensitive to temperature changes. It is therefore recommended that the calibration of a NO sensor is performed at the experimental temperature.

Method 2: Calibration by Decomposition of SNAP Using CuCl₂ as a Catalyst

This method of calibration relies on the use of CuCl₂ for the partial but quantifiable conversion of SNAP to NO. This procedure can be used as an alternative to the previous method in which CuCl is the active catalyst for the conversion of SNAP to NO. In this procedure CuCl₂ (natural form—copper (II) chloride dihydrate) is substituted as a catalyst for ease-of-handling (Sigma Aldrich part number: 307483-500G).

NOTE: Experimentally it has been shown that CuCl₂ is less efficient as a catalyst in the conversion of SNAP to NO (for example, conversion ratio is reduced to approximately 60%). The accuracy of the calibration may also be reduced.

S-Nitroso-N-acetyl-D,L-penicillamine (SNAP) is a stable NO-containing compound that can be used for quantitative generation of NO in solution. SNAP decomposes to NO and a disulfide byproduct when dissolved in water. However, the rate of decomposition is very slow. The kinetics of decomposition for this reagent is a function of several parameters including pH, presence of a catalyst, temperature and light.

In the procedure described here, SNAP is used in combination with a catalyst, cupric (II) chloride (CuCl₂), to generate a known quantity of NO in solution. Note that this protocol does not investigate the effects of all parameters involved in SNAP decomposition nor does it propose a model by which NO is decomposed. The presented procedure provides an empirical estimation of the amount of generated NO based on the molarity of a standard stock solution of SNAP under a controlled set of parameters.

Getting Started

Prepare the following solutions:

Solution #1: Dissolve 5mg EDTA in 250mL of water (HPLC grade).

Solution #2: Prepare 250mL 0.1M cupric (II) chloride in distilled water.

Preparing Standard SNAP Solution

To prepare the standard solution of SNAP, weigh approximately 5.0mg +/- 2.0mg of SNAP and add it to solution #1. Calculate the molarity of SNAP solution. Decomposition of SNAP in the stock solution proceeds very slowly due to the presence of chelating reagent, EDTA. Thus the rate of decomposition is negligible and the stock solution of SNAP remains relatively stable for at least 5 hours if kept in refrigerator.

NOTE: The purity of standard reagent, SNAP, is very important for the reported data. Use high grade SNAP with purity of 95% or better. SNAP can be purchased from WPI (#SNAP25, SNAP50, SNAP100).

TIP: For complete instructions on making standard 100 μ M SNAP and calculating the molarity of SNAP solution, see Appendix B, page 39.

Calibration Procedure

Place 10.0mL of solution #2 in a 20mL vial (supplied in the calibration kit). Drop a small stirring bar into the solution, and place the vial on a magnetic stirring plate. Immerse a NO probe into this solution, and while stirring, allow the background current to stabilize. The appropriate time for stabilization depends on the model of the sensor. Refer to the Appendix A, Table 6, page 35 for suggested times. As soon as the background current becomes stable start the recording.

Next, sequentially inject three aliquots of SNAP solution, 5 μ L, 10 μ L, and 20 μ L, into the vial containing copper chloride solution. The current output will rapidly increase upon addition of first aliquot and will reach a plateau within a few seconds. Inject the second aliquot, 10 μ L, as soon as the first signal reaches a plateau. Finally add the third aliquot as the second signal reaches its plateau. If aliquots are not added promptly when reaching the previous plateau, the signal will slowly decline because generated NO is quickly oxidized to nitrite and nitrate which will not be detected by the probe.

NOTE: You can adjust the volume of injected aliquots according to the concentration of SNAP stock solution. Decrease the volume of aliquot if electrode is very sensitive or increase the volume of aliquot if the electrode is less sensitive.

Because NO sensors can be calibrated in a linear fashion, the magnitude of every signal should almost double as the volume of SNAP solution added is doubled in the course of the calibration. Use the recorded data to construct a calibration curve. The calibration curve can be simply constructed by plotting the signal output (for example, in pA) vs. the concentration of SNAP added at that time. Note that every addition of SNAP solution corresponds to a particular NO concentration. This will be discussed below. After the sensitivity of the NO probe is established, the LabScribe software can be programmed to display data in either concentration directly (for example, nM, mM) or redox current (for example, pA, nA).

The standard SNAP solution can be used for the calibration of NO probes throughout the day. Store the solution in the dark and refrigerate when not in use. Prepare a fresh stock solution of SNAP in the beginning of every day to ensure minimal decomposition of SNAP in the stock solution. Concentration of SNAP decreases to 5-10% of its nominal value after approximately 4-5 hours.

NOTE: Remember that most NO probes are sensitive to changes in temperature. It is therefore recommended that the calibration of your sensor is performed at a constant experimental temperature.

Predicting the Level of Detectable NO According to the Molar Ratio of SNAP in the Presence of Catalyst (Method II)

Experiments have shown that SNAP is decomposed instantaneously under the following set of experimental conditions:

Temperature 25°C

Catalyst solution 0.1M copper chloride

SNAP WPI, 98% purity. Fresh stock solution with 5 mg/250 mL solution EDTA added.

Copper chloride is at equilibrium with ambient air (aerobic conditions).

SNAP (RSNO) decomposes to NO and a disulfide byproduct according to the following equation:



Theoretically, the concentration of generated NO should be equal to the final concentration of SNAP in the copper chloride solution in the calibration vial if the decomposition goes to completion and if the generated NO is detected quickly before it is oxidized to nitrite and nitrate.

However, it is expected that the level of detectable NO will be below the theoretical value because the copper chloride solution is at equilibrium with ambient air, and consequently a portion of the generated NO would have been immediately oxidized to nitrite and nitrate before it was measured by the NO sensor. In addition, it is possible that decomposition of SNAP does not go to completion even in the presence of a catalyst. Results on the kinetics of SNAP decomposition in the presence of a catalyst in an anaerobic environment are published elsewhere (Zhang *et al.*, "Novel Calibration Method for Nitric Oxide Microsensors by Stoichiometrical Generation of Nitric Oxide from SNAP", *Electroanalysis*, 2000, 12: 6).

Our experimental data indicates a conversion efficiency of SNAP to NO of approximately 0.6 (60%). This result is only applicable for calibration of a NO sensor in a solution, which is at equilibrium with ambient air and at the experimental conditions described above. Hence for each mole of SNAP, 0.6 mole of NO is liberated under the proposed set of parameters. It is assumed the other 40% of SNAP is either not decomposed or a proportion that is decomposed to NO is subsequently oxidized immediately before it is detected by the NO sensor.

Example for Creating a Calibration Curve

The following example walks through the calibration procedure just described.

1. Prepare Solution #1 by dissolving 5.0mg EDTA in 250mL of water.
2. Prepare Stock Solution by dissolving 6.4mg SNAP in 250mL of solution #1.

TIP: For complete instructions on making standard 100 μ M SNAP and calculating the molarity of SNAP solution, see Appendix B (page 39).

3. Prepare Solution #2. Prepare 250mL 0.1M CuCl₂ in distilled water.
4. Calculate the concentration of NO in the SNAP solution (molarity).

$$M = m/V$$

Where M is the concentration in molar, m = mass of the substance in moles, V= volume of solution in liters

$$M = [0.0064g / 220.3g/mol] / 0.25L = 0.000116M$$

5. Set up the equipment. Place 10mL of Solution #2 in a vial on the magnetic stirring plate and set up the NO probe. Allow the background current to stabilize before recording.
6. Calculate the total volume in the vial after each addition and record the number. The initial value is 10mL (0.01L). For a three point calibration, the concentrations to be added will be 20 μ L, 40 μ L and 80 μ L. So, the added values are 20 μ L (0.00002L), 40 μ L (0.00004L) and 80 μ L (0.00008 L), and the successive total values after each addition will be 0.01002L, 0.01006L and 0.01014L.
7. Calculate the concentration of SNAP in each amount to be added to the 10mL of Solution #2. Calculate the final concentrations for each addition using the formula for dilutions.

$$M_i V_i = M_f V_f$$

where M_i = initial molarity, V_i = initial volume, M_f = final molarity, V_f = final volume

$$[0.000116M * 0.00002L] / 0.01002L = 231.5nM$$

$$[0.000116M * 0.00004L] / 0.01006L = 461.2nM$$

$$[0.000116M * 0.00008L] / 0.01014L = 915.2nM$$

8. Calculate the effective concentration of NO in the solution after each addition is made. When employing the calibration method that uses CuCl₂, the yield of NO gas is approximately 60% of the concentration of SNAP. Calculate the effective values.

$$[SNAP] * 0.6 = [NO]$$

$$231.5nM[SNAP] * 0.6 = 138.9nM[NO]$$

$$461.2nM[SNAP] * 0.6 = 276.7nM[NO]$$

$$915.2nM[SNAP] * 0.6 = 549.1nM[NO]$$

9. Record all your calculated values in a table similar to the one below.

| Amount added | Total volume | [SNAP] | [NO] |
|--------------|--------------|----------|----------|
| 20 μ L | 0.01002 L | 231.5 nM | 138.9 nM |
| 40 μ L | 0.01006 L | 461.2 nM | 276.7 nM |
| 80 μ L | 0.01014 L | 915.2 nM | 549.1 nM |

10. Add the test liquids and measure the current output. The SNAP reacts with the CuCl₂ producing NO gas. When NO gas passed through the gas permeable membrane, it generates an output current that is measurable, and the results can then be graphed. To the vial containing 10mL of solution #2, add 20 μ L, 40 μ L and 80 μ L of Stock Solution, recording the current measurements after each addition.

| Amount added | [NO] | Current Recorded |
|--------------|----------|------------------|
| 20 µL | 138.9 nM | 230 pA |
| 40 µL | 276.7 nM | 488 pA |
| 80 µL | 549.1 nM | 926 pA |

11. Construct a standard calibration curve using the recorded data. Using a third party spreadsheet with graphing capability like Microsoft® Excel, it is possible to generate a linear regression analysis that will display the equation and the R² coefficient. To do this in Excel, enter the data and generate a “scatter plot” graph. Then, select the line and right click. Choose **Add Trendline**. The **Add Trendline** dialog box appears. On the **Type** tab, select **Linear**, and on the **Options** tab, select the **Display equation on chart** and **Display R-value on chart**.

The data from the calibration curve indicates that this procedure allows an excellent linear calibration of NO probes. The accuracy of calibration is approximately +/- 10% from mean. The source of error arises most probably from gravimetric measurement of the standard reagent, SNAP. In addition, purity of SNAP as well as partial oxidation of generated NO in the calibration solution could contribute to this error. Such a deviation may not be so important when NO is quantified in biological systems because most often the ability to measure changes in the basal concentration of NO is more significant than measurement of the absolute level of NO.

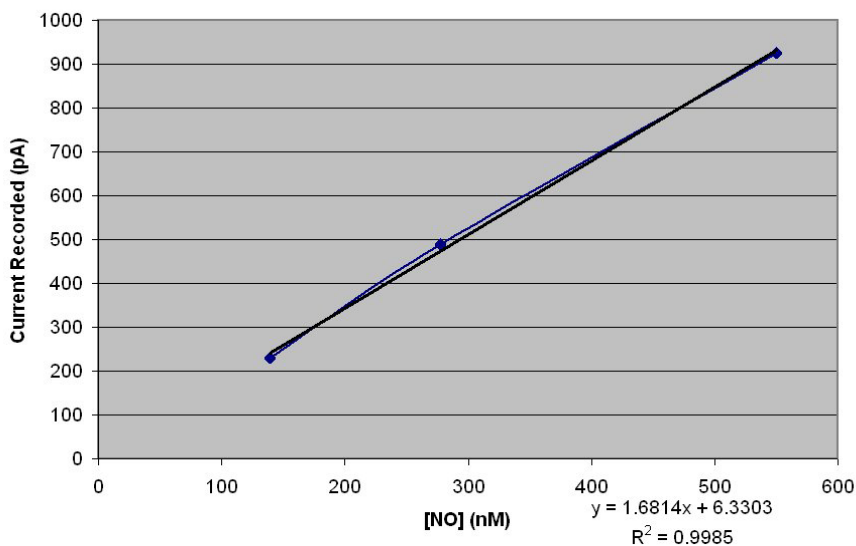

Fig. 9—Scatter plot of data from example

Preparing an NO Standard Using NO Gas

This method can be used with all NO sensors and has the advantage of allowing you to calibrate NO sensors in the same environment in which the experimental measurements will be made. However, it has the disadvantages of added cost, inconvenience, and greater hazard. All of these factors must be taken into consideration.



WARNING: NITRIC OXIDE MUST BE HANDLED ONLY IN A WELL-VENTILATED AREA, TYPICALLY A LABORATORY FUME HOOD WITH FORCED VENTILATION. THE U.S. OCCUPATIONAL SAFETY AND HEALTH ADMINISTRATION HAS SET A TIME-WEIGHTED AVERAGE MAXIMUM NO VALUE AS 25PPM. THAT IS TO SAY, 25PPM IS CITED AS THE MAXIMUM CONCENTRATION TO WHICH WORKERS MAY BE CONTINUALLY EXPOSED. BRIEF INHALATION OF CONCENTRATIONS AS LOW AS 200PPM COULD PRODUCE DELAYED PULMONARY EDEMA WHICH MAY BE FATAL AFTER AN ASYMPTOMATIC PERIOD OF UP TO 48 HOURS AFTER THE INITIAL EXPOSURE. IT IS THEREFORE CRITICAL THAT THE PERSONNEL HANDLING THE GAS BE THOROUGHLY FAMILIAR WITH THE MATERIAL SAFETY DATA SHEET (MSDS) AND PROPER HANDLING PROCEDURES. THE PRECAUTIONS RECOMMENDED BY THE GAS MANUFACTURER MUST BE FOLLOWED.

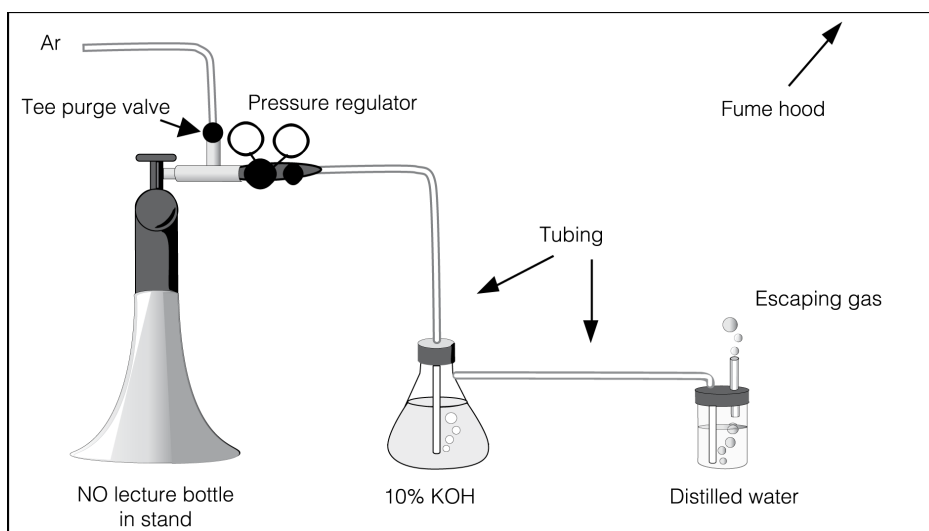

Fig. 10—Setup for preparing a saturated NO aqueous solution.

1. **Be certain the fume hood is functioning. Inhalation of NO gas is potentially fatal. See the WARNING on the previous page.**
2. Make sure that all fittings and connections are secure. The tubing to be used should not be permeable to NO. We recommend Tygon® tubing if a polymer tubing is to be used; this is permeable to NO but has the best performance compared to other polymer tubing of which we are currently aware. Ideally glass tubing should be used. If Tygon® tubing is used, note that prolonged exposure to NO affects its properties; therefore it is recommended that the tubing be inspected frequently and that it be replaced when it appears to be brittle. The pressure regulator and tee purge adaptor should be stainless steel since nitric oxide is corrosive.
3. Prepare 100mL of a 10% (by weight) KOH solution and place it in the sidearm flask as illustrated in **Fig. 8**, above. The flask should be sealed with a stopper through which the tubing passes by means of a Luer fitting to a syringe needle which extends almost to the bottom of the flask. Tubing is used to connect the side arm of the flask to the vial containing the water to be equilibrated with NO. The KOH solution is used to remove other nitrogen oxides from the NO gas.
4. Place 20mL of distilled (preferably deionized) water in a small glass vial. Seal the vial with a stopper and insert through the stopper a long syringe needle which extends almost to the base of the vial. Connect this syringe needle to the tubing from the KOH flask, as illustrated. Insert an additional shorter syringe needle which should not extend into the solution. This acts as a pressure relief during purging.
5. Place the distilled water vial in an ice-water bath. Reducing the temperature increases the solubility of NO in solution. Thus when the solution is used at room temperature you will be assured of a saturated NO solution.
6. Purge the system with argon (or nitrogen) gas for a period of 30 minutes at a moderate flow rate such that the pressure is maintained at a safe level (1-2PSI). When purging it should be observed that gas is indeed bubbling through the KOH solution as well as the distilled water. After 30 minutes turn off the argon source, and switch the tee purge valve to the correct position for purging with NO from the lecture bottle.
7. Purge the system with NO for 5-10 minutes if using a pure source (longer if the NO source is not pure). Again make sure that gas is bubbling solutions.



WARNING: NO IS NOW ESCAPING FROM THE PRESSURE RELIEF NEEDLE IN THE STOPPER OF THE DISTILLED WATER VIAL. IT IS IMPERATIVE THAT THE FUME HOOD BE RUNNING AT MAXIMUM CAPACITY WITH THE FRONT PANEL CLOSED.)

8. After the time in step 7 has elapsed turn off the NO source.
9. Immediately remove the two needles from the distilled water vial.

TBR4100/1025

10. Set the tee purge valve for purging with argon (or nitrogen) gas, and turn on the argon source. Purge the system for 5-10 minutes at a moderate flow rate. Gas should be bubbling through the KOH and then escaping from the flask into the atmosphere. Again be sure that the fume hood is ventilating well.
11. Turn off the argon (or nitrogen) source, and allow the fume hood to continue to ventilate for 10-15 minutes so as to ensure that all traces of NO gas are removed from the atmosphere.
12. The solution of distilled water should now be saturated with NO. The concentration of NO produced by this saturation is dependent upon the temperature. At 0°C, the concentration is approximately 3.3mM, and at 20°C the concentration is approximately 1.91mM.
13. Dilutions of known concentration can be prepared from this saturated solution. In preparing a dilution, be careful not to unseal the vial, for this exposes the solution to atmospheric oxygen.

Once the dilutions are prepared, it is a simple matter to calibrate the instrument.

Measurement of NO

It is not within the scope of this manual to outline in detail how to use NO sensors to measure NO in every experimental set up you may encounter. There are, however, some guiding principles of which you should be aware to exploit fully the capabilities of the technology. These are outlined below.

NO Delivery—For measurement of NO to be made, the NO must reach the sensor surface so it can react on the electrode surface. This point is of particular concern, because in many experiments the lifetime of NO is short. This is especially true in biological systems where compounds such as hemoglobin can reduce the half-life of NO to less than a second. It is therefore critical that the experimental set up is designed to maximize delivery of NO to the sensor. In particular, the tip of the sensor must be placed as close as possible to the site of NO release.

Durability and Handling—Exercise caution when handling any NO sensor to avoid actions which could damage the sensor tip. The sensor membrane and membrane coatings are extremely delicate and improper handling will lead to damage.

Environmental Influences—There are two environmental parameters to which NO sensors are quite sensitive: temperature and electrical interference.

Temperature—Note that the sensitivity of the NO sensor is temperature-dependent. This is due to the effects of temperature on the partial pressure of NO in either liquid or gas samples, on the permeability of the membrane or coatings, and on the conductivities of various circuit components. It is therefore recommended that any calibration is performed at the same temperature as the experiment and that temperature be held constant.

Electrical Interference—Although nitric oxide monitoring using the **TBR4100/1025** involves the measurement of extremely small currents, the intrinsic noise level of the **TBR4100/1025** and NO sensors is low enough to provide accurate measurements of nitric oxide. However, various external electrical noise sources may couple to the system electromagnetically and produce large extraneous signals in the output record. The magnitude of this external noise depends on the environment of the laboratory. If the interference introduced by the electrical signals in the environment is large, ground and shield the system properly.

Maintenance of NO Sensors

The various NO sensors, if well cared for, will require very little maintenance

Maintenance of the ISO-NOP

When the ISO-NOP sensor is not being used it should be left connected to the **TBR4100/1025** in the ON position (or to Pre-Polarizer **NSA-3** with the tip suspended in distilled water.

Maintenance of Nitric Oxide Microsensors

WPI's nitric oxide microsensors are maintenance-free consumable sensors that are warranted against defect for 30 days from the date of purchase. The following information should increase the lifetime of the sensor:

Storage

NO microsensors should be stored dry in a cool place away from direct sunlight. They can also be left attached to an ISO-NO Activator (WPI #NSA-3). The Activator maintains the sensor in a polarized state, ready for immediate use when required. It is not required for NO microsensors to be immersed in solution for the activator to maintain polarization of the electrode.

Setup and Calibration of HPO Sensors

Initial Setup

Plug the HPO sensor into the input connector on the bottom of the required input channel on the **TBR4100/1025**. Set the correct poise voltage for Hydrogen peroxide by selecting "HPO" on the Applied Voltage Control for the channel you are using. Set appropriate gain; For most sensors or applications, 10nA range is appropriate. Be sure to give the sensor enough time to polarize before beginning the calibration.

Calibration of the HPO Sensor

Hydrogen peroxide (H_2O_2) is a very important product in the biological system. The determination of H_2O_2 requires an accurate method of calibration. Amperometric (electrochemical) determination using the **TBR4100/1025** is a very reliable method to measure H_2O_2 . The instrument measures the amount of H_2O_2 oxidized on the surface of the sensor using a poise voltage of +450mV. The oxidation of H_2O_2 at the sensor surface produces a small current (pA), which is detected by the **TBR4100/1025**. The amount of current produced is linearly proportional to amount of H_2O_2 in the experiment.

Items Required

- Plastic stand with two holes
- One glass vial
- 1.0mM H_2O_2 standard solution (To make standard solution, see APPENDIX B, page 39.)
- 0.1M PBS buffer solution (WPI# **TBR-PBS** PBS Standard Solution is available from WPI) (To make your own standard solution, see APPENDIX B, page 39.)

NOTE: The multi-port measurement chamber (WPI #**NOCHM-4**) can be used as an alternative calibration kit, specifically for use at different temperature condition. Calibration temperatures from 4 - 40°C can be controlled using an external circulating bath (contact WPI for information).

Calibration Procedure

1. Turn on the **TBR4100/1025** and connect the **ISO-HPO-2** sensor to the input. Select the poise voltage for hydrogen peroxide using the Applied voltage rotary switch. It is important that the poise is set before plugging in the electrode, because improper poise can cause damage to the electrode. Set the current range to 10nA
2. Measure an appropriate volume (for example, 10mL) of PBS buffer solution into a glass vial. Place the vial on a magnetic stirring plate and put a small stir bar into the vial. Set the stir rate at a medium speed.
3. Remove the sensor from the electrolyte solution in which the tip has been immersed during storage. Immerse the **ISO-HPO-2** sensor tip in PBS buffer solution, The sensor tip should be immersed about 0.3-0.5mm into the solution, and should not be touched by the stir bar.
4. Record the current value after a 10-15 minute settling period. If the current is offscale or unstable after a half hour in solution, it is likely that the membrane has been damaged and the sleeve needs to be changed (refer to the section on "Changing the Membrane Sleeve").

NOTE: The calibration should be carried out at the temperature at which the samples of H_2O_2 are to be measured. This can be accomplished by placing the vial and stand in a water bath at the appropriate temperature, and allowing the temperature of the solution in the bottle to equilibrate with the water bath.

5. In two hours or less, the sensor should achieve a stable baseline current value. See Appendix A, Table 6, page 38 for the appropriate value. At this time, the sensor is ready for calibration.

Creating a Calibration Curve

To create a calibration curve, measure the current (pA) generated by the addition of increasing amounts of H₂O₂ to the calibration solution.

1. Wait for current output to stabilize.
2. Consecutively add known volumes of the H₂O₂ standard solution to the PBS buffer solution. For example, add 0, 5, 10, 20, 40, 80 μL H₂O₂ standard solution (1.0mM) into the 10mL PBS buffer solution. The additions can be added once every 20-30 seconds. The resulting output should look similar to the example in **Fig 11**.

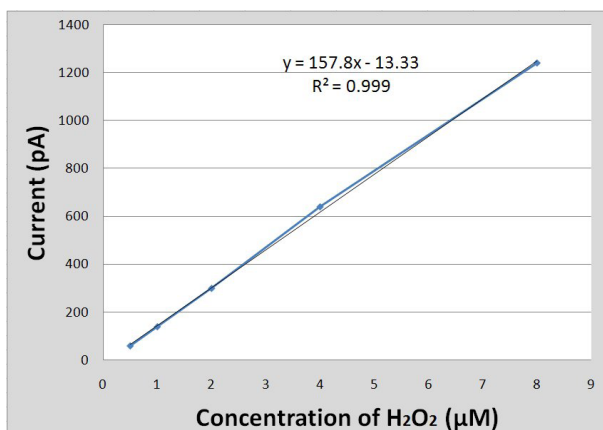

Fig. 11—(Right) Calibration Curve

From this output, a calibration curve **Fig. 12** can be created by plotting the changes in current (pA) against the changes in concentration (mM). The slope of this curve indicates sensitivity of the probe.

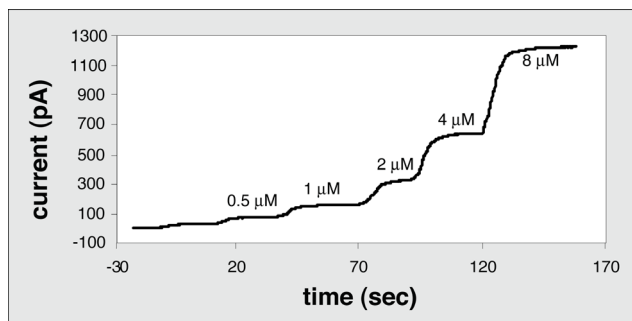

Fig. 12—(Right) Calibration Data

Interference Temperature

The background current of the sensor will usually increase with increasing temperature of the experiment. Although, the sensitivity of the sensor does not change significantly within the range 20-37°C, it is recommended that any calibration should be performed at the same temperature as the experiment.

The sensor works best between pH 3-10. Changing the pH of the solution does not affect the sensitivity. However, if the pH is below 3.0, the noise of the sensor will increase. At pH 10.0 and higher, the response of the sensor will diminish significantly.

Maintenance of HPO Sensors

When the **ISO-HPO-2** sensor is not being used (for short-term storage) it should be connected to the **TBR4100/1025** with power ON and with the tip suspended in 0.1M PBS solution (WPI# **TBR-PBS**). (Do not use water.) This will keep the sensor polarized and ready for immediate use. For long term storage, the sensor should be stored dry in a cool, dark place. Protect the sensor with a used membrane sleeve, if desired.

Storage

Store the electrode with its tip immersed in electrolyte solution in the sealed vial provided with the electrode. For long term storage, remove the membrane sleeve, rinse with distilled water and store dry in a cool, dark location. Protect the inner electrode by using an old membrane sleeve with the membrane removed or place it inside a suitable box to prevent damage.

Setup and Calibration of Oxygen Sensors

The **ISO-OXY-2** in combination with **TBR4100/1025** amperometrically measures the concentration of oxygen in aqueous solutions and can be used short term (2 hours or less) in a gas mixture. The sensor houses a platinum working electrode and a silver counter/reference electrode inside a stainless steel sleeve. A gas-permeable polymer membrane is fitted over the end of the sleeve which allows oxygen to pass while blocking liquids, ions and particulate matter. Oxygen diffuses through the membrane and is reduced at the platinum cathode which is held at -0.7V when the instrument is on. This results in an electrical current being generated, the magnitude of which is determined by the rate of diffusion to the electrode which is proportional to the partial pressure of oxygen outside the membrane. Thus the current serves as a measure of the partial pressure of oxygen.

The **ISO-OXY-2** comes ready to use. Simply, attach the sensor to the **TBR4100/1025**, set the correct poise and voltage, turn the power on and wait for the current to decay to a stable value (this usually takes several hours). (See Appendix A, Table 6, page 38 for polarization time.) The current can be monitored directly on the **TBR4100/1025**. Once the current stabilizes you may then calibrate the electrode.

Initial Setup

Plug the oxygen sensor into the input connector on the bottom of the required input channel on the **TBR4100/1025**. Set the correct poise voltage for oxygen by selecting "O" on the Applied Voltage Control for the channel you are using. Set appropriate gain; for the **ISO-OXY-2**, the 100 nA range is appropriate.

For accurate results the sensor probe must be calibrated at the same temperature expected at the measurement site.

After initially connecting the oxygen sensor to the **TBR4100/1025** in ON position, the probe current will be high. The current will decrease and settle to a stable value after a period of time, typically two to four hours. See Appendix A, Table 6, page 38 for expected current values.

Zero (oxygen) Point Calibration

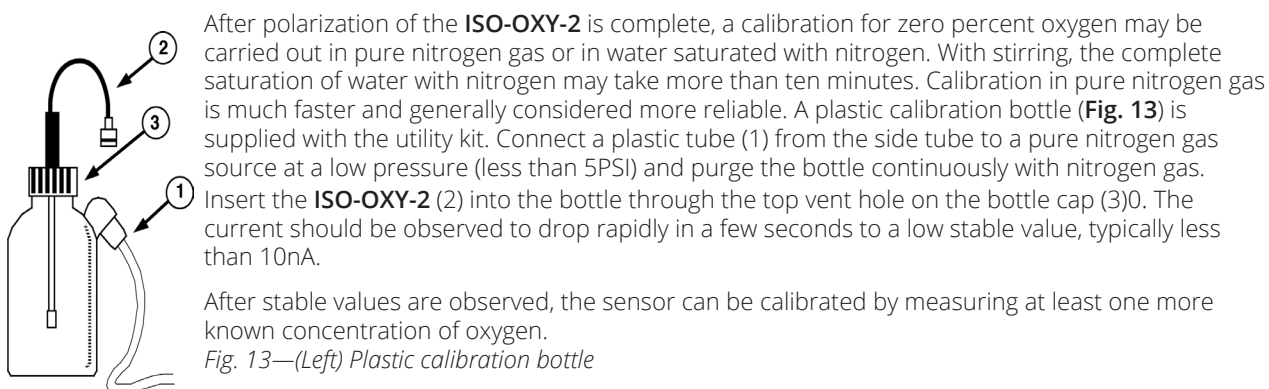

Gas Phase Calibration

Probe calibration for gas phase measurements can be accomplished using the calibration bottle, described above for zeroing the instrument with nitrogen, and using a tank of known oxygen composition, for example 100% O₂.

Alternatively, air can be used as the calibration standard but since water vapor does affect the probe reading it is best to use dry air unless the ambient humidity is accurately known. Dry air can be obtained by passing room air through

a column containing a solid drying agent such as silica gel or calcium chloride and then into the calibration bottle for calibration. Ambient humidity may cause a calibration error of as much as 1% O₂.

The physical interpretation of the percent of oxygen is the percentage of atmospheric pressure that the oxygen present exerts. For example, in a 100% oxygen environment a reading of 100 means that the partial pressure of oxygen is 1atm (760mmHg). A reading of 21 means that the partial pressure of oxygen is 0.21atm (160mmHg).

Fig. 14 (next page) shows a typical record of the calibration procedure. Before point 1 the record displays the background current of the oxygen sensor in air. This current value may vary from sensor to sensor. At point 1 the sensor is exposed to 0% oxygen. At point 2 the background current is zeroed using the software. At point 3 and point 4 the sensor is exposed to air (21% oxygen) and 100% oxygen, correspondingly. By using the current at 0% (0nA) and 100% (236nA), a two-point calibration curve is built and the slope is determined at 2.36nA/%. Alternatively, a three-point calibration can be implemented by adding the information for the current of the sensor in air and by using linear regression software. The dotted line represents a typical linear regression.

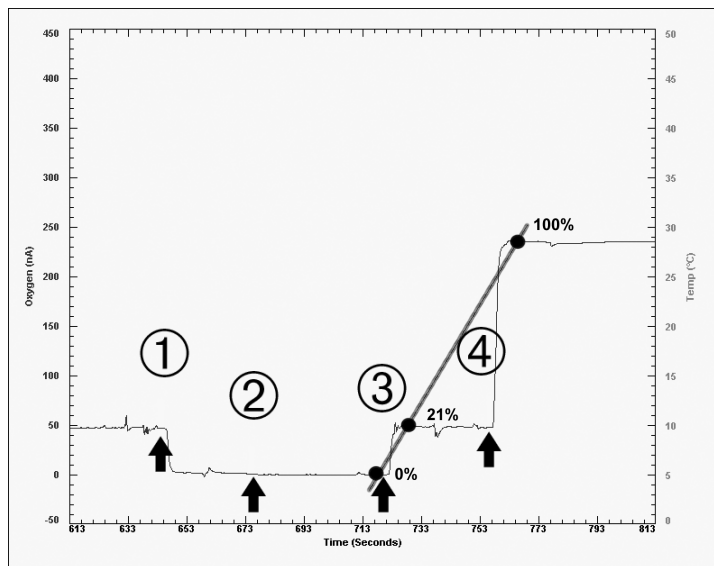

Fig. 14—Typical record of calibration

Aqueous measurements

For aqueous calibration, fill the calibration bottle with distilled water to approximately two thirds of its full volume. Immerse the probe tip into the water via the top hole. Aerate, for a few minutes, by bubbling air through the side arm of the bottle at a low pressure using a simple aquarium aeration pump. The scale reading should be allowed to settle to a stable reading. Dissolved oxygen calibration is corrected for the effect of water vapor by the following equations:

$$(1) p_{O_2} = 21\% \times (1 - p_{H_2O}) \quad \text{or}$$

$$(2) p_{O_2} = 21\% \times (1 - p'_{H_2O}/760)$$

where p_{H_2O} and p'_{H_2O} are the partial pressure of water vapor at standard atmospheric pressure in atmospheres and in mm Hg, respectively.

For example, the p_{H_2O} in water-saturated air at 24°C is 22mmHg (See Appendix A, Table 4). Therefore the $p_{O_2} = 21\% \times (1 - 22/760) = 20.4\%$. Note that for purposes of oxygen measurements liquid water is considered to be “water-saturated air.”

To purge the oxygen from the liquid, connect 1/8" ID plastic tubing (not supplied) to the port on the side of the bottle (Fig. 13). Connect the other end of the tubing to a pure nitrogen gas source at a low pressure (less than 5 PSI). Bubble nitrogen into the calibration medium for at least 10 minutes.

TIP: If you prefer, you may use an oxygen scavenger like Na₂S₂O₄ (Sigma-Aldrich #157953) or Na₂SO₃ (Sigma-Aldrich #71988) to inhibit the oxygen action in the distilled water. Be aware that temperature and salinity changes affect the concentration of the solute needed to purge the oxygen. Be sure to use enough of your oxygen scavenger to completely eliminate the oxygen in the bottle for the duration of the calibration procedure.

 **CAUTION:** Wear nitrile gloves when handling sodium sulfite (Na_2SO_3).

To determine the dissolved oxygen concentration in parts per million (ppm), see Appendix A, Table 1, page 35. This table gives the solubility of oxygen in water at different temperatures at an ambient pressure of 1 atm. If the solution temperature is 25°C, for example, the oxygen concentration when the probe is in water is 8.4ppm. You do not need to correct for the water-vapor effect for a ppm calibration since the values in Table 1 are obtained in “water-saturated air” at an atmospheric pressure of 760mmHg.

The unit ppm is equivalent to mg/L. This is illustrated as follows. The solubility of oxygen in water at 0° according to the Merck index is 4.889mL per 100mL.

Using the ideal gas law we can calculate the number of moles of oxygen present in 100mL:

$$\begin{aligned} PV &= nRT \\ n &= P \cdot V / R \cdot T \\ n &= (0.21) \cdot (4.889 \times 10^{-3}) / (0.08206) \cdot (273) \\ n &= 45.8 \times 10^{-6} \text{ moles} \end{aligned}$$

Where P is the partial pressure of oxygen, V is the volume of oxygen, n is the number of moles of oxygen, R is the universal gas constant, and T is the absolute temperature. From the number of moles of oxygen we can calculate the number of grams of oxygen:

$$\begin{aligned} 45.8 \times 10^{-6} \text{ mol} \cdot 32 \text{ g/mol} \\ 1.46 \times 10^{-3} \text{ g} \end{aligned}$$

Therefore there will be $(1.46 \times 10^{-3} \text{ g} / 0.1 \text{ L})$ 14.6mg of oxygen per liter. Since 1 L of water has a mass of 1000 g, and there are 1 million mg in 1000g, the concentration in ppm shall be:

$$(14.6 \times 10^{-3} \text{ g/L}) / (1000 \text{ g/L}) = 14.6 \text{ ppm}$$

NOTE: This value corresponds to that given in Appendix A, Table 1.

For accurate results the temperature of the water sample and the fluid being tested should be identical, and they should be continuously stirred using a magnetic stirrer.

When measuring fluid samples for dissolved oxygen, periodically rinse the exterior of the probe with distilled water, blot the membrane dry and recheck the electrode’s calibration as described above.

Creating a Calibration Curve

To create a calibration plot, measure the current (nA) of the sensor at various concentrations of oxygen. The calibration is usually either a two-point or three-point calibration, and typically includes measurements at 0% oxygen, air (21% oxygen) or 100% oxygen. Regardless of the calibration points chosen, the corresponding correction for water vapor in case of aqueous measurements should be applied. (See Appendix A, Table 4.)

Calibration Method for O₂ Measurements in Living Tissue/Blood

The TBR4100/1025 and ISO-OXY-2 probe may be used in applications involving O₂ measurements *in vitro* or *in vivo* in living tissue or fluids such as blood. You may still use the calibration procedure in this manual for these measurements since a membrane-covered amperometric oxygen electrode will always measure oxygen **activity**, not concentration. Although it is normal to think in terms of dissolved oxygen concentration, it is actually more appropriate to define oxygen in solution in terms of activity, since this is the “effective concentration”. For example, in distilled water the activity coefficient, γ_c , is close to unity; but in solutions with high salt concentration the activity coefficient is different from unity and concentration and activity of dissolved oxygen are no longer equal: the oxygen concentration falling with salt concentration increase, while activity remains constant. For a membrane-covered oxygen electrode this is an important effect since an oxygen detector only responds to the difference in activity across the membrane rather than the concentration difference. So in samples containing an electrolyte, while the oxygen concentration falls with increasing salt concentration the probe current remains constant.

Thus, if it is necessary to have a measure of dissolved oxygen in terms of concentration, then the calibration is somewhat more complicated since the relationship between activity and concentration may change with the change

of salt concentration in the samples. The activity coefficient, a ratio of the activity to the concentration, generally cannot be predicted and one must rely on empirical determinations since the compositions of living fluids such as blood are extremely complicated. One may directly use the fluid to be tested as a “solvent” to prepare a calibration standard. Alternatively, one may use the Bunsen absorption coefficient (α), to calculate oxygen concentration in blood in terms of the results with the oxygen electrode. The equation is:

$$C = \frac{\alpha}{\text{molar volume} \times K} \times (P_t - P_{H_2O}) \times P_{O_2}$$

where K is a conversion factor depending on the unit of pressure chosen (1 per atm), P_t and P_{H_2O} are the total pressure of gas and the partial pressures of water respectively. P_{O_2} is the partial pressure of oxygen in blood obtained from the measurements with the oxygen electrode. Bunsen coefficients for solubility of oxygen in plasma and blood can be found in Appendix A, Table 5, page 37. However, it is very important to calibrate at the same temperature as that of the measurement site.

Care of the Electrode

The reduction of oxygen and other trace impurities causes a decrease in the surface activity of the working electrode. This phenomenon is referred to as “poisoning,” and over time has the effect of gradually reducing the electrode’s capability to generate a sufficient redox current. As such, it is recommended to use the following guidelines to maximize the life of the electrode:

If the oxygen electrode is being used on a daily basis, it’s recommended that the instrument be left ON continuously with the electrode connected to maintain polarization. However, if the electrode is not to be used for a period of more than 2-3 days, it’s recommended that the electrode be disconnected from the instrument, and stored with the tip immersed in distilled water. This practice will reduce the possibility of a gradual reduction of electrode surface activity (as discussed above) under long term polarization. If the electrode will not be used for a long period of time (several months), refer to the “Storage” section below.

Handling Precaution

When passing the O_2 probe through small holes, gaskets or O-rings, allow sufficient clearance so that the probe tip is not damaged by abrasion. The probe tip should slide through openings easily before sealing the probe shaft to assure an air-tight fit.

Storage

For long term storage (several months) unscrew and remove the sleeve from the probe handle, rinse the electrode tip and the sleeve with distilled water. When both are dry, replace sleeve to protect probe wand but do not screw the sleeve completely onto the handle.

Setup and Calibration of Glucose Sensors

IGS100 implantable glucose sensor for real-time monitoring is an amperometric microsensor that can be used *in vivo*. The implantable, sensing tip is slightly larger than a half-millimeter in diameter. The tip is comprised of a metal coil with an enzyme-soaked cotton core. A proprietary coating covers the entire tip. As the sensor is used, the enzyme is consumed.

The tip design resists contamination from biological materials, which significantly improves the life of the sensor. Depending on measurement conditions, **IGS100** may be used *in vivo* for weeks or even months. When not in use, it has a six-month shelf life.



Fig. 15—IGS100 sensor

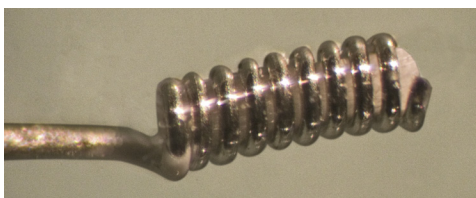

Fig. 16—Tip of the sensor showing the coil holding the enzyme saturated cotton plug. The diameter of the coiled tip is about 600 μ m.

Initial Setup

1. Turn on the **TBR4100** or **TBR1025**.
2. Set the **Probe Select** dial (poise voltage) on the **TBR4100** or **TBR1025** to the **GLU** setting (+600mV).
3. Plug the **IGS100** glucose sensor into the microsensors cable (WPI #**91580**) and plug the other end into the input for the appropriate channel of the **TBR4100** or **TBR1025**.
4. Immerse the sensor element into a 5mM glucose solution with 0.05M PBS buffer (pH=7.4). (WPI# **TBR-PBS**)
5. Place a magnetic stirring bar into the solution. Turn on the stirrer so that the bar is stirring at a moderate rate. It takes about 3-4 hours to stabilize the first time.

NOTE: The rate of the stirrer should not be modified once it is set.

Preparing Solution for Calibration

Prepare a 2M glucose standard solution by dissolving 7.2g glucose into 20mL distilled water. Let the solution stand overnight at room temperature to allow equilibration of anomers. Store solution at 4°C.

Calibrating the IGS100

1. Condition the sensor as described above.
 2. Remove the sensor from the glucose solution. Rinse the sensor with distilled water.
 3. Immerse the glucose sensor tip into 20mL of 0.05M PBS solution.
 4. Place a magnetic stirring bar into the solution. Turn on the stirrer so that the bar is stirring at a moderate rate.
- NOTE:** The rate of the stirrer should not be modified once it is set.
5. After waiting a few minutes for the current to stabilize, record its value. Typically the current should be a few nA or less. (It should not exceed 20nA.)

NOTE: The calibration should be carried out at the temperature at which the measurement of glucose is to be made. This can be accomplished by placing the vial and stand in a water bath at the appropriate temperature, and allowing the temperature of the solution in the bottle to equilibrate with water bath.

5. Once the current has achieved a stable value, record this value or use zero function in the instrument to set the baseline to zero.
6. Add 20 μ l of the 2M stock glucose solution into the 20mL of 0.05M PBS buffer solution. The concentration of glucose in the solution is now 2mM. The current output will rapidly increase upon addition of glucose and reach a plateau in a couple minutes.
7. Add an additional 20 μ l aliquot of 2M stock glucose solution when the signal reaches a plateau. The concentration of glucose in the solution is increasing by 2mM with the addition of each aliquot. When the current output reaches a plateau, record the value displayed on the free radical analyzer.
8. Repeat step 7 another three times. A typical calibration plot looks similar to the one shown in **Fig. 17**.

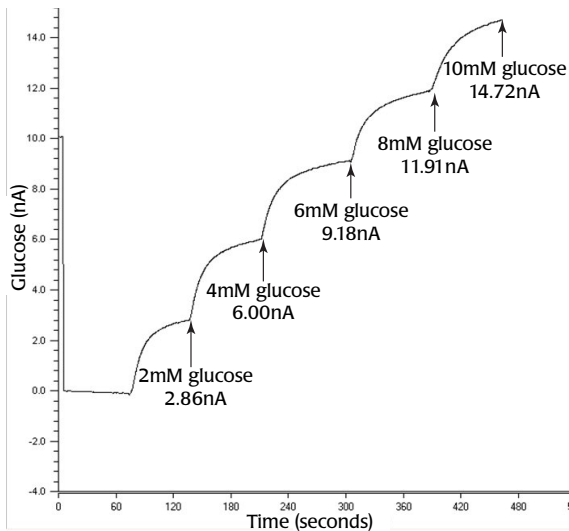

Fig. 17—Calibration plot showing five aliquots of 2M glucose injected into PBS solution

- Plot the current readings against the total glucose concentration on a graph. The slope of this line indicates the sensitivity of the glucose sensor. Once the sensitivity of the glucose sensor is known, the sensor is ready for experimental use.

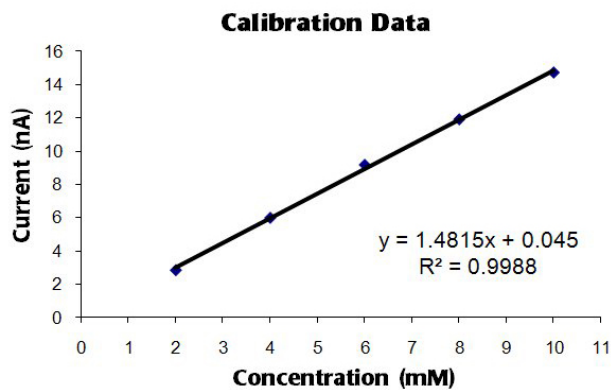

Fig. 18—Calibration data plotted shows the linear rise in current with the increase of the solution molarity

NOTE: Since the enzyme is consumed as the sensor is used, the sensor should be re-calibrated before each experiment.

Sensor Care and Maintenance

Storing the Sensor

STANDBY: If the sensor is being used the next day, it should be stored with the tip suspended in 5mM glucose solution at 4°C.

LONG-TERM: For long-term storage of more than one week, rinse the sensor tip with distilled water and let it dry. Protect the tip and store the sensor dry at 4°C. It is best to store the sensor in its original box with the tip suspended.

Maintaining the Sensor

After each use, rinse the sensor with distilled water.

Sterilizing the Sensor

The sensor can be sterilized chemically using an appropriate disinfectant (for example, Cidex, WPI#7364).



CAUTION: Do not use alcohol on the sensor.

Setup and Calibration of CO Sensor

The **ISO-COP-2** is a carbon monoxide sensor with a replaceable stainless steel membrane sleeve filled with an electrolyte solution that measures CO in vivo or in vitro in real time!

Replacement membrane sleeves can be purchased in packages of four (WPI #95620), along with filling solution (WPI #95611). A startup kit for this sensor is available and is recommended for the first purchase of this sensor type (WPI #95699).

NOTE: Carbon monoxide sensors are not calibrated at the factory because of the toxic nature and inherent dangers of CO. For information on calibration, see the reference: **Roberto Motterlini, Philip Sawle, Sandip Bains, Jehad Hammad, Roger Alberto, Roberta Foresti, Colin J. Green** "CORM-A1: a new pharmacologically active carbon monoxide-releasing molecule" *The FASEB Journal* express article 10.1096/fj.04-2169fje, November 19, 2004 (<http://www.fasebj.org/content/early/2005/01/27/fj.04-2169fje.full.pdf>).

Sensor Design

The **ISO-COP-2** is an amperometric sensor designed for use in cell culture and similar applications.

In principle, CO diffuses through the gas-permeable membrane and is then oxidized to CO₂ on the working electrode of the sensor. This oxidation creates a current with a magnitude directly related to the concentration of CO in solution.

It is designed for use with WPI's **TRB4100** (4-Channel Free Radical Analyzer), **TBR1025** (1-Channel) or the **Apollo1000**.

Notes and Warnings



WARNING: CARBON MONOXIDE GAS MUST BE HANDLED ONLY IN A WELL-VENTILATED AREA, TYPICALLY A LABORATORY FUME HOOD WITH FORCED VENTILATION. THE U.S. OCCUPATIONAL SAFETY AND HEALTH ADMINISTRATION HAS SET A TIME-WEIGHTED AVERAGE (8-HOUR) (TWA) PERMISSIBLE EXPOSURE LIMIT (PEL) OF CARBON MONOXIDE AS 50PPM. THE ACGIH THRESHOLD LIMIT VALUE (TLV) FOR CARBON MONOXIDE IS 25PPM TWA. THAT IS TO SAY, 50PPM IS CITED AS THE MAXIMUM CONCENTRATION TO WHICH WORKERS MAY BE CONTINUALLY EXPOSED. OVEREXPOSURE MAY RESULT IN HEADACHES, DIZZINESS, CONVULSIONS, LOSS OF CONSCIOUSNESS AND DEATH. CARBON MONOXIDE IS ALSO EXTREMELY FLAMMABLE. IT IS THEREFORE CRITICAL THAT THE PERSONNEL HANDLING THE GAS BE THOROUGHLY FAMILIAR WITH THE MATERIAL SAFETY DATA SHEET (MSDS) AND PROPER HANDLING PROCEDURES. THE PRECAUTIONS RECOMMENDED BY THE GAS MANUFACTURER MUST BE FOLLOWED.



CAUTION: DO NOT EXPOSE SENSOR TO ORGANIC SOLVENTS.



CAUTION: Carefully read the "Probe Unpacking" instructions (found in the sealed sensor case) before handling the sensor.

NOTE: The sensor must be polarized for at least 12 hours in 0.1M PBS buffer solution (WPI# **TBR-PBS**) prior to use.

NOTE: The sensor membrane and membrane adhesive are extremely delicate. Improper handling will lead to damage of the sensor. The **ISO-COP-2** is designed for use in liquids.

NOTE: For optimal use of each sensor and sensor membrane sleeve, the sensor must be stored properly. See "Storing the Sensor" on page 28.

Environmental Influences

There are two environmental parameters to which CO sensors are quite sensitive: temperature and electrical interference.

TBR4100/1025

Temperature—The background current (and to a lesser degree) the selectivity of the CO sensor is affected by temperature. This is due to the effects of temperature on the partial pressure of dissolved CO gas in liquid samples, on the permeability of the membrane and on the conductivities of various sensor components. It is recommended that the calibration procedure be performed at the same temperature as the experiment and that temperature be held constant during CO measurement.

Electrical Interference—External, electrical noise sources (like fluorescent lights, MRI machines, electric motors, computers, pumps and other electrical instruments) may couple into the sensor signal path electromagnetically and impose undesirable signals in the output record. The magnitude of this external noise depends on the environment of the laboratory. If the interference introduced by the electrical signals in the environment is large, the first step towards eliminating it is to ground and shield the system properly.

TIP: Refer to your free radical analyzer manual for proper grounding and shielding techniques. (In the **TBR4100** or **Apollo1000** manuals, see "Grounding and Noise Concerns" in the Operating Instructions section.)

Setup

The CO electrolyte filling solution (WPI #**95611**) must be made fresh when you are ready to use the sensor, so the **ISO-COP-2** sensor is shipped with a dry membrane sleeve. Before using it, you must fill the sleeve with the CO electrolyte filling solution. Use the membrane sleeve that was shipped on your sensor and follow the instructions for replacing a membrane sleeve (page 9) to setup your sensor for its polarization, calibration and first use.

NOTE: Since the membrane sleeve that was on the sensor during shipping was dry, the membrane was not damaged by placing it on the sensor. That membrane sleeve is still good to use.

Polarizing the Sensor

1. Place the sensor in 0.1M PBS solution (WPI# **TBR-PBS**).
2. Plug it into the free radical analyzer.
3. Turn on the free radical analyzer.
4. Set the poise voltage to 950mV.
5. The **ISO-COP-2** sensor should be allowed up to 12 hours to reach a stable baseline current of 1000-8000pA before it is used for measurement.
6. During initial polarization the current is typically very high (well above 10nA), but within an hour it will begin to decrease rapidly. In order to observe this phenomenon, start by setting the range to 100nA. After several hours the current will fall below 10nA. At that time, adjust the range to 10nA. The 10nA range setting is required to provide adequate resolution for viewing the sensor's response to carbon monoxide.
7. If the stabilized baseline value exceeds 8000pA, see "Replacing the Membrane Sleeve" on page 9.

NOTE: This polarization procedure assumes the temperature is 25°C. At 37°C the baseline current is higher. If the current exceeds 10nA, it may be required to adjust the current range up to 100nA.

Durability and Handling

The sensor is relatively durable, except for the membrane sleeve. Exercise caution when handling any CO sensor to avoid actions that could damage the sensor tip. Pay particular attention to the sensor membrane, because the membrane is extremely delicate and improper handling will lead to damage.

Refer to the Probe Unpacking Instructions that came with your sensor for handling instructions.



CAUTION: Do NOT scratch the sensor membrane sleeve. Do NOT wipe the *sensor membrane* with anything, even Kimwipes. If necessary, squirt it with distilled water or compressed air.



CAUTION: The sensor membrane is easily punctured if it comes into contact with sharp objects. For example, do NOT let the stir bar come into contact with the sensor membrane.

Storing the Sensor

With proper care and by following the instructions below a membrane sleeve should last more than one month.

STANDBY: If the electrode is being used on a daily basis, it should be left connected to the free radical analyzer in the ON position with the tip suspended in distilled water.

LONG-TERM: For long-term storage of more than one week, remove the membrane sleeve, clean the sensor tip with deionized water and dry carefully. Protect the tip and store the sensor with the membrane removed in a dry, cool environment.

Cleaning the Membrane

The membrane sleeve itself requires very little maintenance. The primary concern is to avoid damage to the membrane and to keep it as clean as possible. After each use the membrane should be cleaned by suspending the tip in distilled water for 20-30 minutes to dissolve salts and remove particles which may have accumulated on it. If the probe was used in a protein-rich solution, the tip should first be soaked in a protease solution for several minutes to remove protein build-up, and then in distilled water. Enzymatic detergent (for example, Enzol, WPI#**7363**) can also be used.

Accumulated organic matter can be removed by briefly immersing the tip in a 0.1M HCl or 0.1M NaOH (at times both may be necessary) for 10 seconds.

A good indication of a dirty membrane sleeve is a sluggish response or an unusually low sensitivity. If these problems are not rectified by cleaning, then the membrane sleeve should be replaced.

Sterilizing the Membrane

The membrane sleeves can be sterilized chemically using an appropriate disinfectant (for example, Cidex, WPI#**7364**).



CAUTION: Do not use alcohol on the sensor.

ACCESSORIES

| WPI Part # | Description |
|-----------------|---|
| IGS100 | Implantable Glucose Sensor |
| ISO-NOP | Nitric Oxide Sensor, 2mm |
| ISO-NOPNM | Nitric Oxide Sensor, 100nm |
| ISO-NOPF100 | Flexible Nitric Oxide Microsensor, 100µm, 1-5mm length |
| ISO-NOPF200 | Flexible Nitric Oxide Microsensor, 200µm, 1-5mm length |
| ISO-NOPF100-LXX | Flexible Nitric Oxide Microsensor, 100µm, 1-10mm length, L-shaped |
| ISO-NOPF200-LXX | Flexible Nitric Oxide Microsensor, 200µm, 1-10mm length, L-shaped |
| ISO-NOPF500-CXX | Flexible Nitric Oxide Microsensor, 500µm, 5-10mm length |
| ISO-NOPF200-L10 | Flexible Nitric Oxide Microsensor, 200µm, 10mm length, L-shaped |
| ISO-HPO-2 | Hydrogen Peroxide Macro Sensor, 2mm |
| ISO-HPO-100 | Hydrogen Peroxide Microsensor, 100µm |
| ISO-HPO-100H | Hydrogen Peroxide Microsensor, 5mm, Hypodermic sheath |
| ISO-HPO-100-LXX | Hydrogen Peroxide Microsensor, L-Shaped, Custom tip length (1-10mm) |
| ISO-OXY-2 | Oxygen Sensor, 2mm |
| ISO-TEMP-2 | Temperature Sensor |
| TBR-PBS-CAL | PBS Calibration Solution |
| TBR-NO-CAL | TBR NO Calibration Solution (CuCl ₂ for NO Sensor Calibration) |

SPECIFICATIONS

This unit conforms to the following specifications:

Both the **TBR4100** and **TBR1025** conform to the same standards, except for the number of channels.

| | |
|-----------------------------------|--|
| Power | 100 ~ 240 VAC, 50-60 Hz, <15 W |
| Operating Temperature (ambient) | 0 - 50°C (32 - 122°F) |
| Operating Humidity (ambient) | 15 - 70% RH non-condensing |
| Warm up Time | <5 minutes |
| Dimensions | 135 X 419 X 217mm(5.25" X 16.5" X 8.16") |
| Weight | 1.35 kg (3 lb) |
| Display Functions | 18 mm (0.7") LCD readout, 4.5 digit |
| | Polarization Voltage (mV) |
| | Current input (nA, μ A) |
| Controls | Power (on/off) |
| | Current Input Range |
| | Polarization Voltage |
| Analog Output Range | +/- 10 V |
| Analog Output Impedance | 10 k Ω - 10 k Ω |
| Channel to Channel Isolation | >10 G Ω - 10 g Ω |
| Channel to Output Isolation | >10 G Ω - 10 g Ω |
| Power Supply to AC Line Isolation | >100 M Ω - 100 m Ω |
| Analog Output Drift | <10 pA/H |

NOTE: The **TBR4100/1025** incorporates a universal power supply that is internally protected with a fusible link. In the event of a power supply failure, the fusible link will open to disconnect power from the unit. The fusible link is not user serviceable. If the **TBR4100/1025** fails to power up, contact WPI Technical Support.

Temperature Input

| | |
|--------------------|--------------------------|
| Number of Channels | 1 |
| Sensing Element | Platinum RTD, 1000 Ohm |
| Range | 0-100°C |
| Accuracy | +/- 1°C |
| Resolution | 0.1°C |
| Analog Output | 31.25 mV/°C (continuous) |

Amperometric Input

| | |
|---|-------------|
| Number of Amperometric Channels | 4 |
| Signal Bandwidth | 0-3 Hz |
| Polarization Voltage (selectable via rotary switch) | |
| Nitric Oxide | 865 mV |
| Hydrogen Sulfide | 150 mV |
| Hydrogen Peroxide | 450 mV |
| Glucose | 600 mV |
| Oxygen | 700 mV |
| ADJ (user adjustable) | +/- 2500 mV |
| Polarization Voltage Accuracy | +/- 5 mV |
| Polarization Voltage Display Resolution | +/- 1 mV |

TBR4100/1025

Current Measurement Performance

| Range | Analog Output | Noise @ 3Hz * | Noise @ 0.3 Hz * |
|----------------|------------------|---------------|------------------|
| +/- 10 nA | 1 mV / 1 pA | < 1 pA | < 0.3 pA |
| +/- 100 nA | 1 mV / 10pA | < 7 pA | < 3 pA |
| +/- 1 μ A | 1 mV / 100pA | < 70 pA | < 30 pA |
| +/- 10 μ A | 1 mV / 1 μ A | < 700 pA | < 300 pA |

*Instrument performance is measured as the (max-min) over a 20-second period with open input. Typical values are given at 3 Hz and 0.3 Hz bandwidth.

Typical sensor performance with TBR4100/1025

ISO-NOPF100 noise 0.2 nM NO (<2 pA)**

**Sensor noise is measured as the (max-min) over a 20 second period with the sensor immersed in 0.1 M CuCl₂ solution.

APPENDIX A: REFERENCE TABLES

Table 1: Solubility of Oxygen in Fresh Water

| °F | °C | ppm | °F | °C | ppm |
|----|----|------|----|----|-----|
| 32 | 0 | 14.6 | 66 | 19 | 9.4 |
| 34 | 1 | 14.2 | 68 | 20 | 9.2 |
| 35 | 2 | 13.8 | 70 | 21 | 9.0 |
| 37 | 3 | 13.5 | 72 | 22 | 8.8 |
| 39 | 4 | 13.1 | 73 | 23 | 8.7 |
| 41 | 5 | 12.8 | 75 | 24 | 8.5 |
| 43 | 6 | 12.5 | 77 | 25 | 8.4 |
| 45 | 7 | 12.2 | 79 | 26 | 8.2 |
| 46 | 8 | 11.9 | 81 | 27 | 8.1 |
| 48 | 9 | 11.6 | 82 | 28 | 7.9 |
| 50 | 10 | 11.3 | 84 | 29 | 7.8 |
| 52 | 11 | 11.1 | 86 | 30 | 7.6 |
| 54 | 12 | 10.8 | 88 | 31 | 7.5 |
| 55 | 13 | 10.6 | 90 | 32 | 7.4 |
| 57 | 14 | 10.4 | 91 | 33 | 7.3 |
| 59 | 15 | 10.2 | 93 | 34 | 7.2 |
| 61 | 16 | 10.0 | 95 | 35 | 7.1 |
| 63 | 17 | 9.7 | 97 | 36 | 7.0 |
| 64 | 18 | 9.5 | 99 | 37 | 6.9 |

NOTE: In a 100% O₂ environment, these parts per million values can be multiplied by a factor of 4.739 (based on the formula $PV=nRT$) when only the partial presence of O₂ is changing.

Table 1: Solubility of oxygen in parts per million (ppm) in fresh water at different temperatures, in equilibrium with air at barometric pressure of 760 mm Hg (101.3 kPa) and oxygen partial pressure of 159 mm Hg (21.1 kPa).

Table 2: Solubility of Oxygen in Seawater

| °C | 5 g/l | 10 g/l | 15 g/l | 20 g/l |
|----|-------|--------|--------|--------|
| 0 | 13.8 | 13.0 | 12.1 | 11.3 |
| 1 | 13.4 | 12.6 | 11.8 | 11.0 |
| 2 | 13.1 | 12.3 | 11.5 | 10.8 |
| 3 | 12.7 | 12.0 | 11.2 | 10.5 |
| 4 | 12.4 | 11.7 | 11.0 | 10.3 |
| 5 | 12.1 | 11.4 | 10.7 | 10.0 |
| 6 | 11.8 | 11.1 | 10.5 | 9.8 |
| 7 | 11.5 | 10.9 | 10.2 | 9.6 |
| 8 | 11.2 | 10.6 | 10.0 | 9.4 |
| 9 | 11.0 | 10.4 | 9.8 | 9.2 |
| 10 | 10.7 | 10.1 | 9.6 | 9.0 |
| 11 | 10.5 | 9.9 | 9.4 | 8.8 |
| 12 | 10.3 | 9.7 | 9.2 | 8.6 |
| 13 | 10.1 | 9.5 | 9.0 | 8.5 |
| 14 | 9.9 | 9.3 | 8.8 | 8.3 |
| 15 | 9.7 | 9.1 | 8.6 | 8.1 |
| 16 | 9.5 | 9.0 | 8.5 | 8.0 |
| 17 | 9.3 | 8.8 | 8.3 | 7.8 |
| 18 | 9.1 | 8.6 | 8.2 | 7.7 |
| 20 | 8.7 | 8.3 | 7.9 | 7.4 |
| 21 | 8.6 | 8.1 | 7.7 | 7.3 |
| 22 | 8.4 | 8.0 | 7.6 | 7.1 |
| 23 | 8.3 | 7.9 | 7.4 | 7.0 |
| 24 | 8.1 | 7.7 | 7.3 | 6.9 |
| 25 | 8.0 | 7.6 | 7.2 | 6.7 |
| 26 | 7.8 | 7.4 | 7.2 | 6.7 |
| 27 | 7.7 | 7.3 | 6.9 | 6.5 |
| 28 | 7.5 | 7.1 | 6.8 | 6.4 |
| 30 | 7.3 | 6.9 | 6.5 | 6.1 |

Table 2: Solubility of oxygen (milligrams/liter) in seawater of different salinities, in equilibrium with air at barometric pressure of 760 mm Hg (101.3 kPa) and oxygen partial pressure of 159 mm Hg (21.2 kPa).

Table 3: Oxygen Solubility vs. Altitude

| Altitude (feet) | Pressure (mm Hg) | Solubility Correction Factor |
|-----------------|------------------|------------------------------|
| -540 | 775 | 1.02 |
| Sea Level | 760 | 1.00 |
| 500 | 746 | 0.98 |
| 1000 | 732 | 0.96 |
| 1500 | 720 | 0.95 |
| 2000 | 707 | 0.93 |
| 2500 | 694 | 0.91 |
| 3000 | 681 | 0.90 |
| 3500 | 668 | 0.88 |
| 4000 | 656 | 0.86 |
| 4500 | 644 | 0.85 |
| 5000 | 632 | 0.83 |
| 5500 | 621 | 0.82 |
| 6000 | 609 | 0.80 |

Table 3: Oxygen solubility obtained from Table 1 or Table 2 should be corrected if barometric pressure is different than 760 mm Hg or at altitudes other than sea level.

Table 4: Saturated Water-Vapor vs. Partial Pressure in mm Hg

| Temp. °C | PvH ₂ O mm Hg | Temp. °C | PvH ₂ O mm Hg |
|----------|--------------------------|----------|--------------------------|
| 0 | 5 | 20 | 18 |
| 2 | 5 | 22 | 20 |
| 4 | 6 | 24 | 22 |
| 6 | 7 | 26 | 25 |
| 8 | 8 | 28 | 28 |
| 10 | 9 | 30 | 32 |
| 12 | 11 | 32 | 36 |
| 14 | 12 | 34 | 40 |
| 16 | 14 | 36 | 45 |
| 18 | 16 | 38 | 50 |
| | | 40 | 55 |

Table 4: Saturated Water-Vapor vs. Partial Pressure in mm Hg**Table 5: Bunsen Coefficients (α) for Solubility of Oxygen in Plasma and Blood**

| Temp °C | Plasma | ----- Blood Hb g/100 mL ----- | | | |
|------------|--------|-------------------------------|--------|--------|--------|
| | | 5 g | 10 g | 15 g | 20 g |
| 15 | 0.0302 | 0.0310 | 0.0312 | 0.0316 | 0.0323 |
| 20 | 0.0277 | 0.0282 | 0.0284 | 0.0287 | 0.0293 |
| 25 | 0.0257 | 0.0261 | 0.0263 | 0.0265 | 0.0271 |
| 28 | 0.0246 | 0.0249 | 0.0251 | 0.0253 | 0.0259 |
| 30 | 0.0238 | 0.0241 | 0.0243 | 0.0245 | 0.0251 |
| 35 | 0.0220 | 0.0226 | 0.0227 | 0.0229 | 0.0234 |
| 37 | 0.0214 | 0.0220 | 0.0221 | 0.0223 | 0.0228 |
| 40 | 0.0208 | 0.0221 | 0.0212 | 0.0214 | 0.0219 |

Table 6: Range of Standard Calibration Values for Various Probes

| Sensor Model | Analyte Species | Typical Quiescent Baseline Current, 25°C | Observed Acceptable Baselines | Nominal Sensitivity for New Sensor | Typical Polarization Time |
|------------------------------|-----------------|--|-------------------------------|------------------------------------|---------------------------|
| ISO-NOP | NO | 1000-8000pA | 1000-8000pA | 2pA/nM | 12 hours |
| ISO-NOPF-100 ISO-NOPF-200 | NO | 500-4000pA | 500-4000pA | 10pA/nM | ≥2 hours |
| ISO-NOP007 | NO | 300-500pA | 200-1500pA | 1-4pA/nM | ≥2 hours |
| ISO-NOP3005 | NO | 200-400pA | 150-3500pA | 1-4pA/nM | ≥2 hours |
| ISO-NOP3020 | NO | 500-5000pA | 2000-6000pA | 1-4pA/nM | ≥2 hours |
| ISO-NOP30L | NO | 600-1000pA | 200-6500pA | 1-4pA/nM | ≥2 hours |
| ISO-NOP70L | NO | 4000-5000pA | 2000-6000pA | 1-4pA/nM | ≥2 hours |
| ISO-NOPNM | NO | 200-300pA | 200-1200pA | | |
| ISO-HPO-2 | H2O2 | 800-900pA | 20-1000pA | 0.2pA/nM | ≥2 hours |
| ISO-HPO-100 | H2O2 | 400-500pA | 150-1200pA | 1pA/nM | ≥1 hour |
| ISO-OXY-2 | O2 | 15-40nA | 15-40nA | 0.3-0.6nA/%O2 | ≥1 hour |
| IGS100 | Glucose | 2-15nA | 2-15 nA | 2nA/mM | 12 hours |
| ISO-COP-2 | CO | 3000pA | 1000-8000pA | ~0.5pA/NM | 12+ hours |

APPENDIX B: STANDARD SOLUTIONS

This appendix describes how to make standard solutions used in procedures in this manual.

Standard 1mM H₂O₂ Solution

Hydrogen peroxide solution is commercially available and is commonly sold with a stabilizer compound in solution. Usually these solutions are within a known concentration range (for example, 2-4% H₂O₂). There are many published procedures for standardizing H₂O₂ solutions, such as the titration method using potassium permanganate. The H₂O₂ sensor can detect low NM concentrations, so, WPI recommends the following procedure.

1. Weigh 67.5mg Acetanilide (Sigma-Aldrich 397237) and dissolve it into 250 mL of dH₂O in a volumetric flask.
2. Remove 1mL of this solution and put it in a clean container.
3. Add 231µL of 2-4% H₂O₂ (Sigma-Aldrich 323381) to the flask.
4. Then, use the removed 1mL of solution from step 2 to dilute the solution in the flask to exactly 250mL again.
5. Store this standard solution in an amber bottle, if available, or alternatively, wrap aluminum foil around the bottle to limit light intrusion. This solution should be refrigerated.

200mL of 0.1M PBS Buffer Solution

Dissolve 1 Sigma tablet (Sigma-Aldrich P4417-100TAB) into 200mL deionized water (DIW). This solution yields 0.01M phosphate buffer, 0.0027M potassium chloride and 0.137M sodium chloride, pH 7.4, at 25 °C.

100µM Standard SNAP Solution

SNAP is a green crystalline compound that is sold in 25mg, 50mg and 100mg vials (WPI # SNAP25, SNAP50, SNAP100). Both the crystalline form and the liquid solution of SNAP are photo-sensitive and tend to degrade over time. Wrap the vial of SNAP compound in aluminum foil and store it in the freezer to slow its degradation. Similarly, store the bottle of SNAP solution in an amber bottle or wrap it with aluminum foil and store it in the refrigerator.

NOTE: The decomposition of SNAP at low temperature, in the dark and in the absence of trace metal ions proceeds slowly because of the EDTA (a chelating reagent).

WPI technicians recommend making fresh standard SNAP solution daily to ensure accurate calibration of NO sensors.

To make a 100µM solution of SNAP:

1. Accurately weigh out 5.0mg EDTA (a preservative) and place it in a clean, dry bottle that will hold at least 250mL. EDTA is available from Sigma-Alrich (ACS reagent 99.4–100.6% powder, p/n: E9884).
2. Use a clean, dry 250mL volumetric flask to accurately measure 250mL of HPLC pure water (HPLC grade, Sigma).
TIP: If your research demands an oxygen-free sample, you can de-oxygenate this solution by purging it with pure nitrogen or argon gas for 15 minutes.
3. Pour the water into the bottle with EDTA. Replace the cap and shake it for a few seconds to dissolve the EDTA. It dissolves rapidly.
4. Accurately weight out 5.6mg of crushed, crystalline SNAP.
TIP: Crush any clumps of SNAP powder with a clean instrument like a glass stirring rod, a popsicle stick or a tooth pick. If you prefer, place the 5.6mg SNAP on a small piece of filter paper, fold the paper in half and rub it gently between your fingers to break up any clumps. Be careful not to spill any of the compound.
5. Add the 5.6mg SNAP to the EDTA solution. Verify that none of the green SNAP compound is left on your filter paper or measuring tray. Replace the cap and shake it for a few seconds until the green flecks dissolve into solution.
6. Store this standard solution in an amber bottle, if available, or alternatively, wrap aluminum foil around the bottle to limit light intrusion. This solution should be refrigerated.

The concentration of SNAP (f.w.= 220.3) in the stock solution is calculated as follows:

$$[C] = [A \cdot W / (M \cdot V)] 1000$$

TBR4100/1025

[C] = concentration of SNAP (μM)

A = purity of SNAP

M = formula weight of SNAP (220.3g/mol)

W = weight of SNAP (mg)

V = volume of the solution (L)

If SNAP purity is 98.5%, the concentration of standard SNAP stock solution describe above is:

$$[C] = [0.985 \times 5.6\text{mg} / (220.3\text{g/mol} \times 0.25\text{L})] \times 1000 = 100.1 \mu\text{M}$$

NOTE: The purity of SNAP used is extremely important to ensure an accurate calibration. We recommend the use of high grade SNAP with minimal purity of 98% or better.

APPENDIX C: USING TBR4100/1025 WITH LABSCRIBE

LabScribe is a full-featured data acquisition application. The basic functions of this program are outlined below. However, the entire LabScribe manual is available in the program's help. The following pages describe how to optimize LabScribe routines and functions for use with the **TBR4100/1025**.

Install LabScribe Software

CAUTION: BEFORE attaching Lab-Trax hardware, you MUST install the LabScribe software.

To install LabScribe software and drivers:

1. Insert the LabScribe CD. It should begin automatically. If not, open **Windows Explorer** and navigate to the CD. Double click on LabScribeXXX.exe (or the latest version of the file). The **Setup Wizard** displays (Fig. 19).

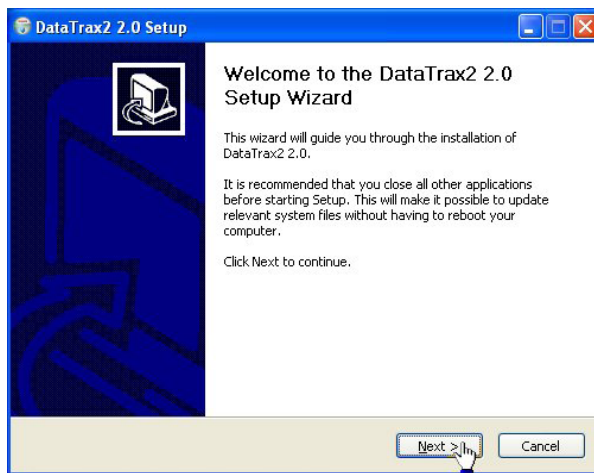

Fig. 19—Setup Wizard

CAUTION: Do NOT connect the LabScribe USB cable until all the files have been installed. If the unit was connected to the USB port during installation, the drivers must be re-installed. For step by step instructions, see Reinstalling the Drivers Manually, page 71.

TIP: For the latest version of the LabScribe software, visit www.wpiinc.com. Search for the **TBR4100**, and click on the Manuals and Resources tab.

2. Click the **Next** button. Then, the **License Agreement** appears (Fig. 20).

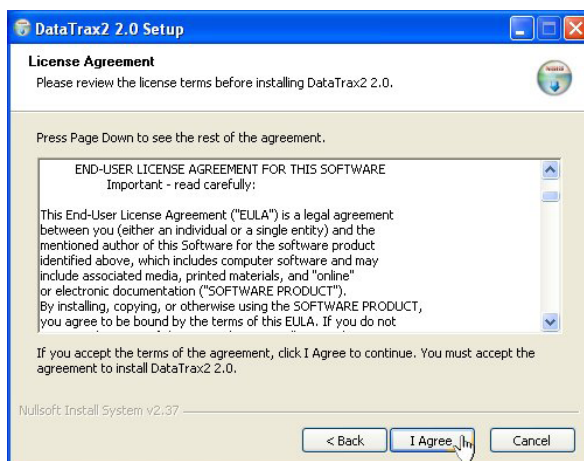

Fig. 20—License Agreement

3. After reviewing the license agreement, click the **I Agree** button. The wizard will then ask for a choice of components to install (**Fig. 21**).

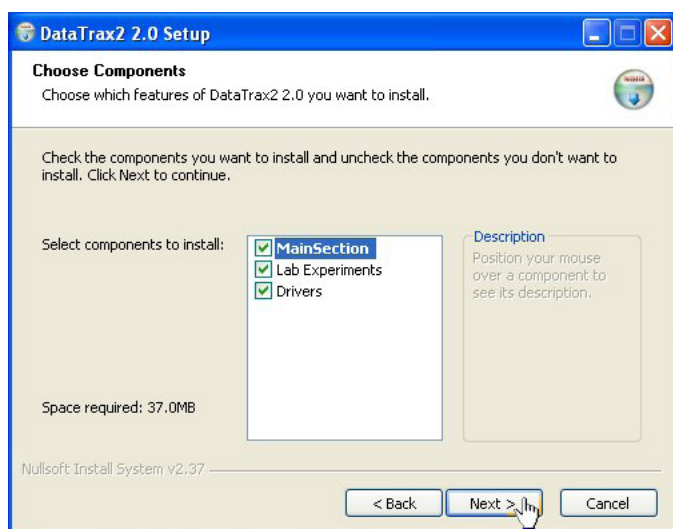

Fig. 21—Component Choice

4. Verify that all three components (Main Section, Lab Experiments, and Drivers) are selected, and click the **Next** button. The wizard will ask where to install the program files (**Fig. 22**).

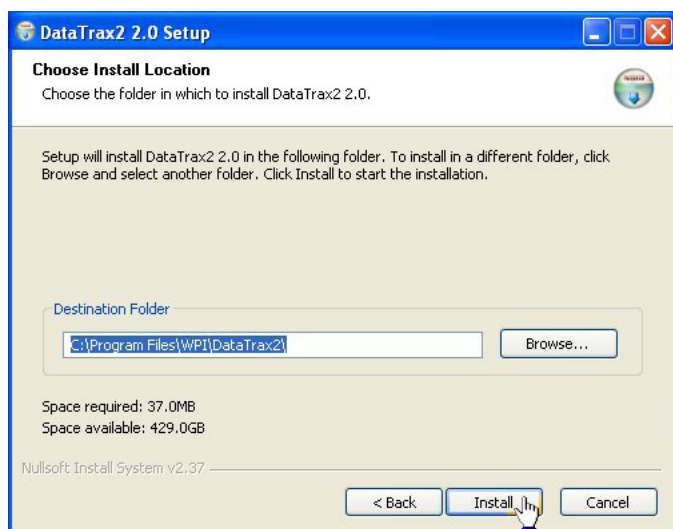

Fig. 22—Install location

- Accept the default location or click the **Browse** button and select the desired location. Once the location is chosen, click the **Install** button. A window displays briefly showing the progress of the installation (**Fig. 23**).

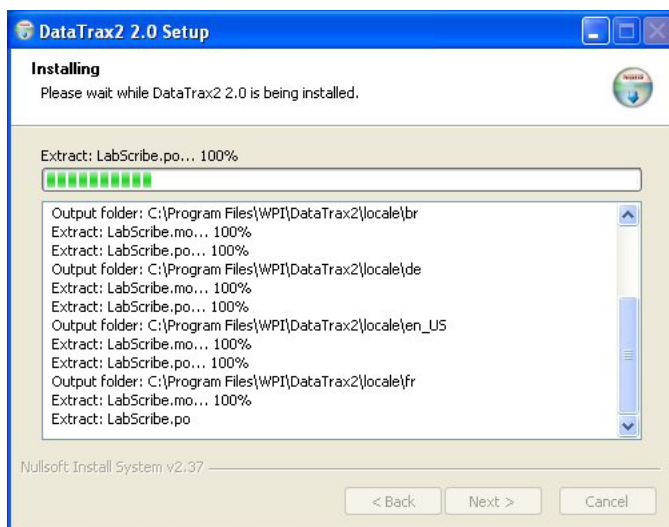

Fig. 23—Install progress

- When finished, a completion message displays (**Fig. 24**). Click the **Finish** button.



Fig. 24—Install completed

- After the software and drivers are successfully installed, connect the LabTrax and **TBR4100/1025**.
 - Insert one end of the Lab-Trax USB cable to the USB port on a computer running Windows XP or Vista and the other end into the USB port of the LabTrax data acquisition system.
 - Connect the output ports of the **TBR4100/1025** to the input ports of the LabTrax.
 - Power on the **TBR4100/1025**.
 - If necessary, power on the LabTrax hardware. (The LabTrax 4_16 device is automatically powered through the computer.)

- After a few moments, the **Found New Hardware Wizard** appears (Fig. 25) Select the **No, not at this time** radio button and click the **Next** button. The wizard asks how to install the hardware (Fig. 26).

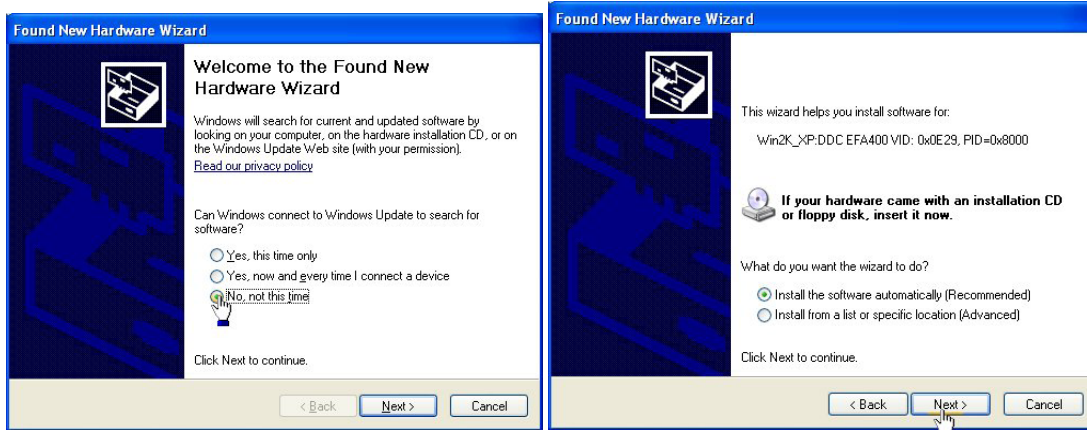

Fig. 25—(Left) Found New Hardware Wizard

Fig. 26—(Right) Type of install

- Select the **Install the software automatically (Recommended)** radio button and click the **Next** button. A Windows warning displays (Fig. 28).

NOTE: If the wizard displays a list and asks for a driver selection (Fig. 27), select the **Win2K_XP:DDCEFA400VID:0x0E29.PID=0x8000** driver and click the **Next** button. Then the warning (Fig. 28) appears.

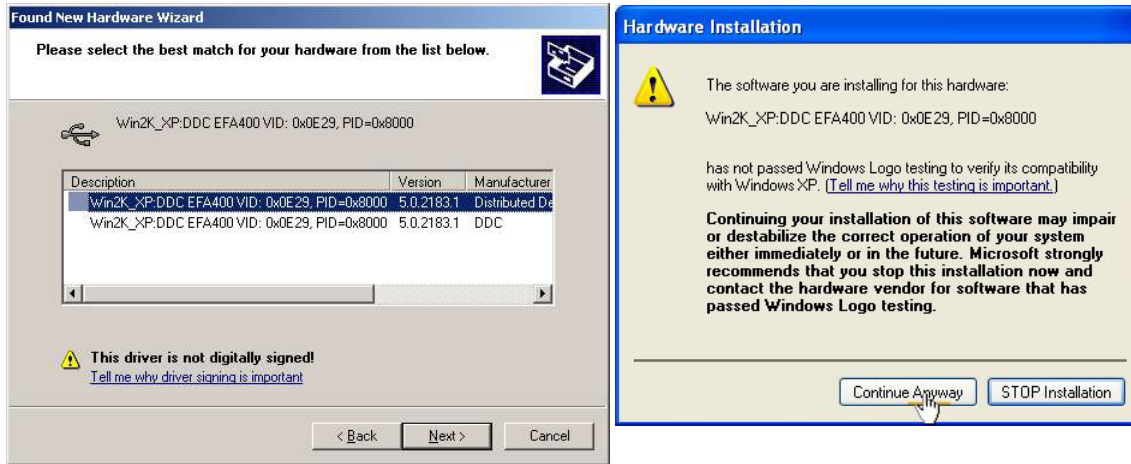

Fig. 27—(Left) Select driver

Fig. 28—(Right) Warning

- Click the **Continue Anyway** button. When finished, a completion message displays (Fig. 28).

- Click the **Finish** button.



Fig. 29—Install completed

Launch LabScribe

- After installing the program and the drivers, launch LabScribe from the desktop icon. The first time the LabScribe program is launched, the **Mode** dialog box appears (Fig. 30). If it is not the first launch, go to step 4.
- Under normal conditions, highlight **Research** and click the **OK** button. Then, the **Language** dialog box appears (Fig. 30).

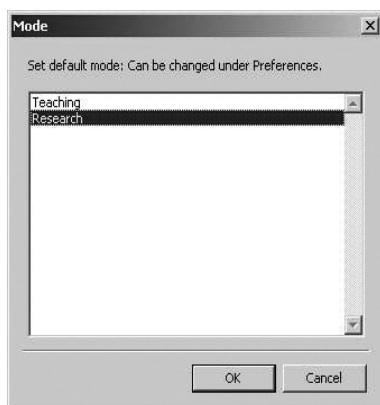

Fig. 30—(Left) Mode dialog box (left)



Fig. 31—(Right) Language dialog box (right)

NOTE: The **Teaching** mode masks some of the more advanced functions for simplicity, therefore, if the teaching mode is selected, some functionality is not readily available.

- Highlight **System default** or the language of your choice and click the **OK** button (Fig. 28).
- An information box appears indicating the hardware that was found. For example, Fig. 32 shows a LabTrax 4_16, and Fig. 33 shows a WPI-118. The default LabScribe main window appears (Fig. 34).

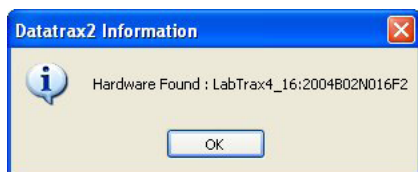

Fig. 32—(Left) LabTrax 4_16 hardware was found

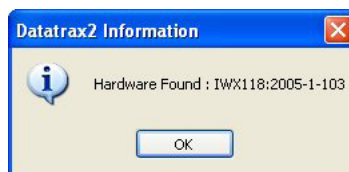

Fig. 33—(Right) WPI-118 hardware was found

TBR4100/1025

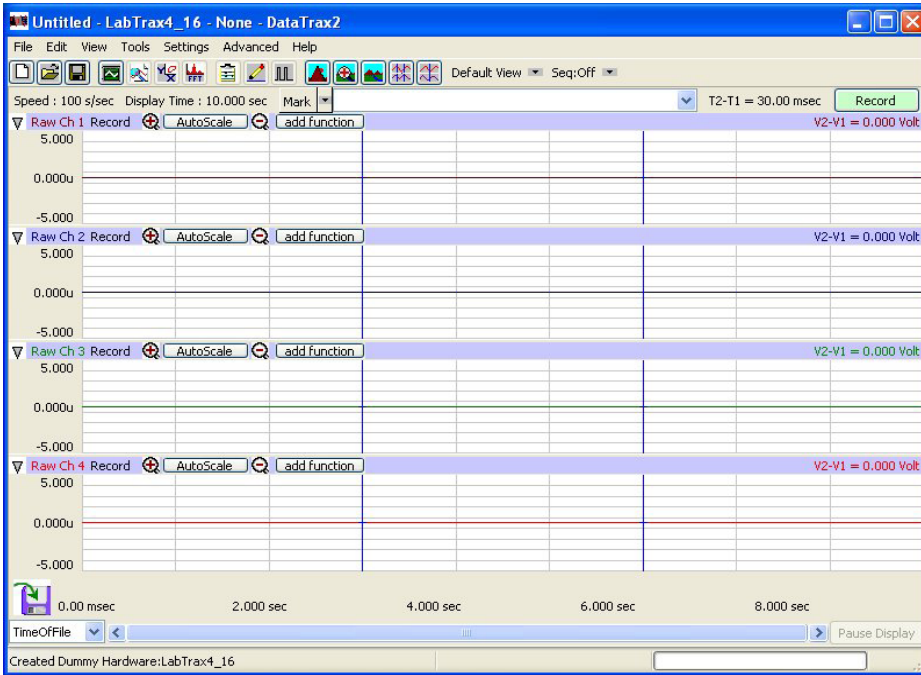

Fig. 34—Main LabScribe window

NOTE: if no hardware is connected to the computer when LabScribe is launched, the **Find Hardware** dialog box (Fig. 35) appears when LabScribe is launched. Select the appropriate hardware device and click the **OK** button. (For the TBR4100/1025, select **LabTrax4_16**.)

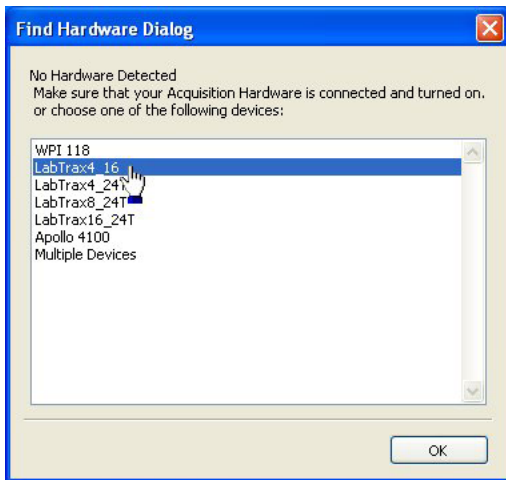

Fig. 35—Found Hardware dialog box

Configuring LabScribe for the TBR4100/1025

The LabScribe main window may be used with its default settings to record information, but because LabScribe is a general-purpose data acquisition software, it may be desirable to optimize the settings for use with the TBR4100/1025. WPI recommends the following configuration changes to optimize LabScribe for the TBR4100/1025.

- To change the basic default settings, open the **Preferences Dialog** window (Fig. 37) by selecting the **Edit** menu and choosing **Preferences (Right)**.

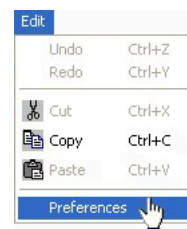
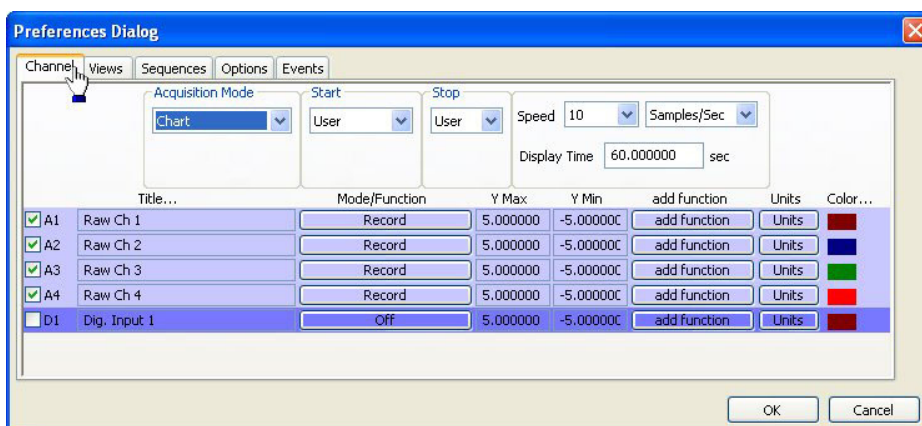

Fig. 36—Preferences Dialog window, Channel Tab (right)

From the Preferences Dialog window, the following options may be modified to suit the research need:

- Number of channels (up to four)
- Sampling rate
- Width of the LabScribe display window – This defines the increment of time displayed in a single frame.
- Height of the LabScribe display window – This defines the range of the voltage display in the LabScribe window. The voltage range for any channel may be conveniently scaled automatically by clicking on the **Autoscale** button located on the header bar of the appropriate channel.
- Channel name (optional)

NOTE: At any time, you may select the default settings by choosing the **Settings** menu and selecting **Default**. This will configure the system to display the maximum number of channels available and sets the default values for the data window width and height.

- Select the **Channel** tab at the top of the **Preferences Dialog** window. This tab allows for configuration of all channels (Fig. 35).
- Use the two **Speed** drop down boxes to select the number of samples (first drop down box) per unit of time (second drop down box). See Fig. 37. The sampling rate should be chosen to record fast enough to create a minimum of two to three points of data for the fastest signal expected when recording. For use with the **TBR4100/1025**, WPI recommends setting the speed between 10 and 20 samples per second.

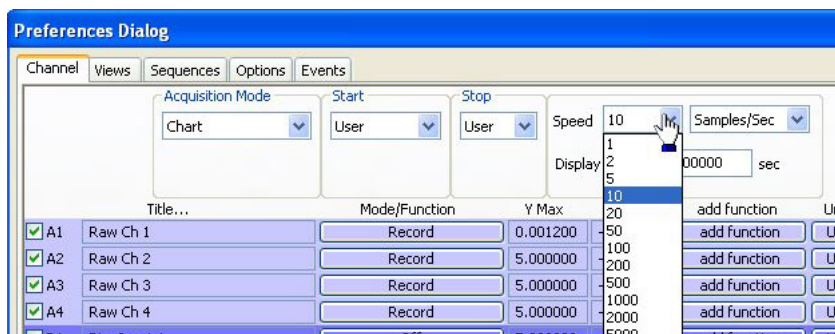

Fig. 37—Select number of samples from Speed drop down lists

TBR4100/1025

- Set the **Display Time** to 60.0 seconds (**Fig. 37**). The elapsed sampling time displays at the bottom of the default LabScribe main window. This value determines the amount of time viewable in a single data frame, or the “width” of the display window.

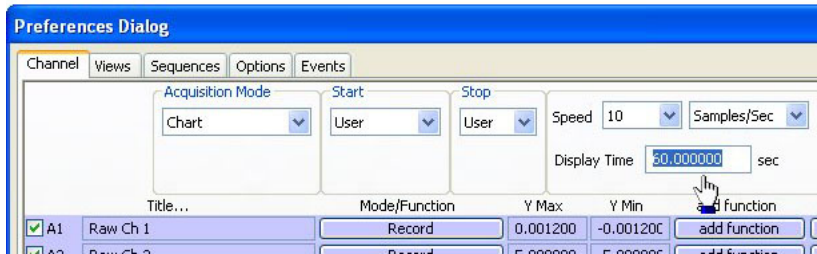

Fig. 38—Enter the display time

- The voltage values shown in the **Y Max** and **Y Min** columns are used to enter user-defined upper and lower vertical limits for the display of each channel. This range can be adjusted while recording, but it is generally set to a large value +5V and -5V until a prescaling factor or a calibration has occurred. This value determines the range of voltages viewable in a single data frame, or the “height” of the display window.
- When all settings have been entered, click the **OK** button.

Prescaling a Channel for the TBR4100/1025

Prescaling narrows the parameters so that signal responses are more immediately visible on screen when they occur, but this does not account for variations of individual sensors. As described here, *prescaling cannot be used to calibrate a sensor*. Any type of input can be prescaled.

NOTE: LabScribe opens with the last used configuration settings. Before beginning a prescale, it is advisable to reset the display to the default settings. To do so, select **Default** from the **Settings menu**. To set the prescaling values for a channel:

- Open the **Preferences Dialog** window to change setting by selecting the **Edit** menu and choosing **Preferences**.

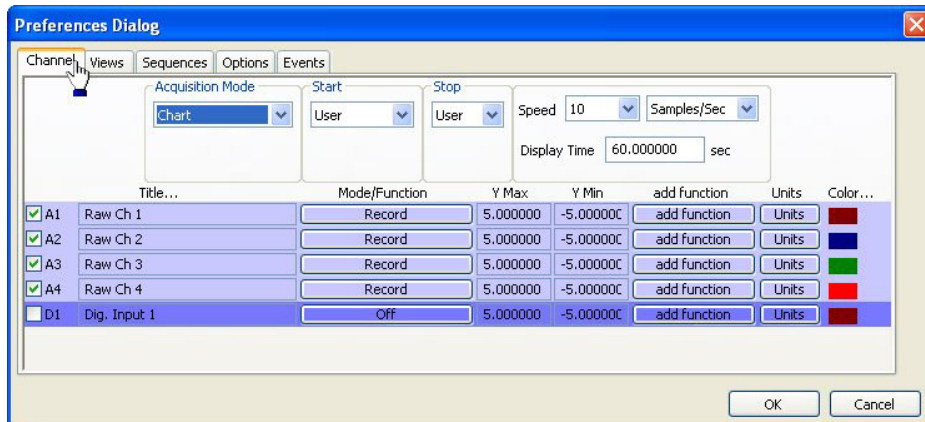

Fig. 39—Preferences Dialog window, Channel Tab

- Select the **Channel** tab from the **Preferences Dialog** window (**Fig. 39**). A list of channels displays in the bottom half of the window. A1 represents channel one, A2 represents channel 2, etc. A check in the checkbox next to a channel indicated that it is selected to receive data input. Each field on the table is configurable.
- For prescaling, click the **Units** button (on the right) for the desired channel. The **Simple Units Conversion** dialog box appears (**Fig. 40**). Use the two-point calibration and verify that the **Apply units to all blocks** check box is selected.

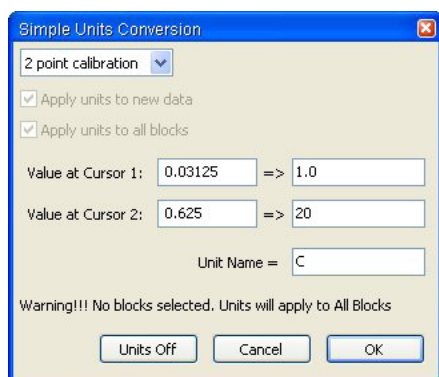

Fig. 40—(Right) Simple Units Conversion dialog box: temperature conversion

NOTE: This **Simple Units Conversion** dialog box will also appear when you right click on a channel in the main display window, select **Units** and then choose **Simple**. This is especially helpful after a recording has begun.

4. Enter the appropriate values, as shown in the table below. Notice that various voltage ranges are shown, as well as a temperature range that is used for temperature prescaling.

NOTE: For calibration of a temperature probe, use the two-point entry on two known temperatures (ice-water, etc.). See Channel Calibration (simple two point), below.

| Scale | Value at Cursor 1 | Value at Cursor 2 | Unit Name |
|-------------|--------------------|-----------------------------------|-----------|
| 10 nA | 0.00 (V) = 0.00 pA | 1.00 V = 1000 pA | pA |
| 100 nA | 0.00 (V) = 0.00 pA | 1.00 V = 10,000 pA (10 nA) | pA |
| 1 μ A | 0.00 (V) = 0.00 pA | 1.00 V = 100,000 pA (100 nA) | pA |
| 10 μ A | 0.00 (V) = 0.00 pA | 1.00 V = 1,000,000 pA (1 μ A) | pA |
| Temperature | 0.03125 = 1°C | 0.625V = 20°C | °C |

5. Click **OK** to close the **Simple Units Conversion** dialog box.
6. Click **OK** to close the **Preferences Dialog** window.

Channel Calibration (simple two point)

To perform a simple two-point calibration:

1. Pre-record two sets of data in the desired channel, one data set at the zero reference point and the other at a known value.
2. Press the double cursor icon  in the tool bar near the top of the screen. This places two blue vertical lines on the main LabScribe window.
3. Position the computer's arrow cursor over the first blue line, hold down the left mouse button and drag the left blue vertical line to the zero point location of the data displayed.
4. In the same way, drag the right cursor to the known calibration point.
5. Next, open the **Simple Units Conversion** dialog box (**Fig. 41**) by positioning the mouse over the recorded data of the channel and right clicking. Select **Units** and choose **Simple**.

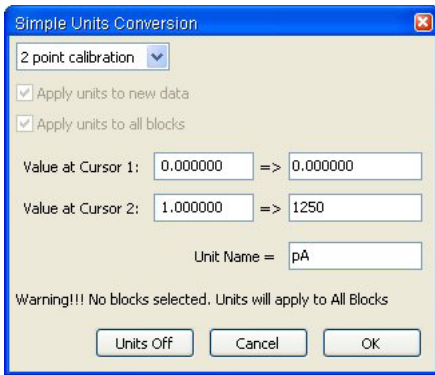

Fig. 41—(Right) Simple Units Conversion dialog box: 5nA conversion example

6. Select **2 point calibration** from the drop down list, and enter the calibration values determined in steps 3 and 4 into the **Value at Cursor 1** and **Value at Cursor 2** text boxes. Enter the units of measure in the **Unit Name** field. Then, click the **OK** button. The next recording will be displayed in the units of measure selected.

NOTE: This calibration applies to only one channel at a time. To remove a calibration and return to the volts display, open the **Simple Units Conversion** dialog box (**Fig. 38**) for the channel and click the **Units Off** button.

TIP: To display a running meter beside the main LabScribe display window (**Fig. 42**), select the **View** menu and choose **Voltmeter**.

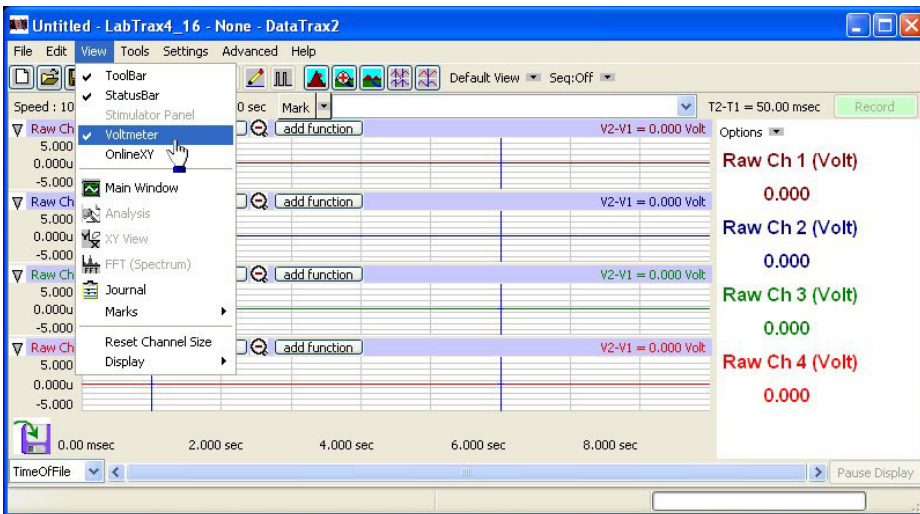

Fig. 42—Main LabScribe window with voltmeter

Plotting a Calibration Line

The LabScribe software incorporates a multipoint calibration function which can be used to plot a line using values from measured samples so that values for unknown samples can be extrapolated.

NOTE: If **Research** was chosen as the operating mode during the installation process, then full access to all the functions was enabled. If **Teaching** mode was chosen, some options are masked, including the Multipoint feature. In Teaching mode, the Multipoint feature must first be enabled before performing a multipoint calibration. To enable a masked feature, open the **Preferences Dialog** window (**Edit>Preferences**) and select the **Options** tab (**Fig. 43**). From the **Main Window Functions** list on the right, highlight **Multipoint Calibration** and any other features to be enabled, and click the **OK** button.

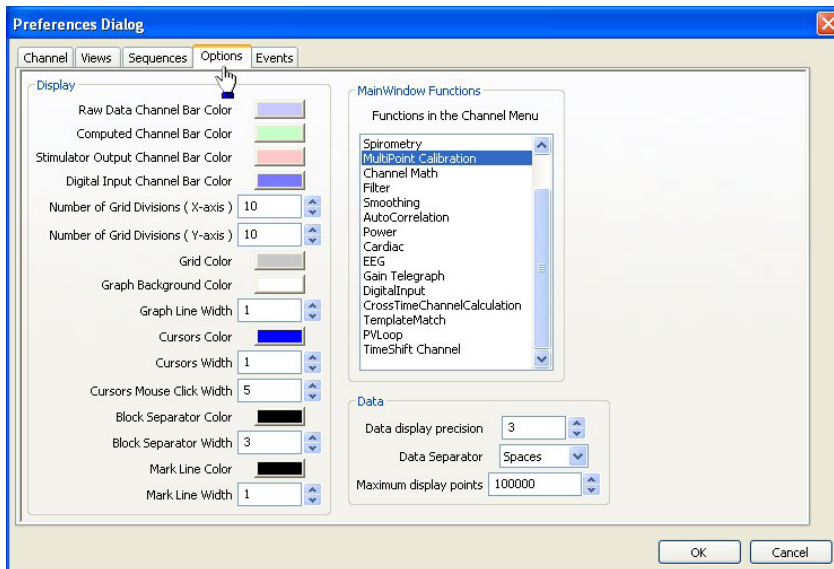

Fig. 43—Preferences dialog box, Options tab

The Multipoint Calibration function uses linear regression techniques on measured values to generate a “least squares fit” calibration line. This calibrated graph can then be referred to for extrapolating the values of unknown samples.

1. Record data for known samples (**Fig. 44**). The example used a ISO-NOPF200 probe, and the recording shows the results of nitrous oxide (NO) measurements when 2, 4, 8, 16 and 32 μ L injections of 100 μ M SNAP are introduced into 20mL of 0.1M CuCl₂ solution. The voltage quickly increases with each addition of SNAP. Then, the value steadily decreases due to the quick oxidation of NO. After each injection, the graph shows a small upward peak. This is a normal artifact generated mechanically by the response of adding SNAP to the solution.

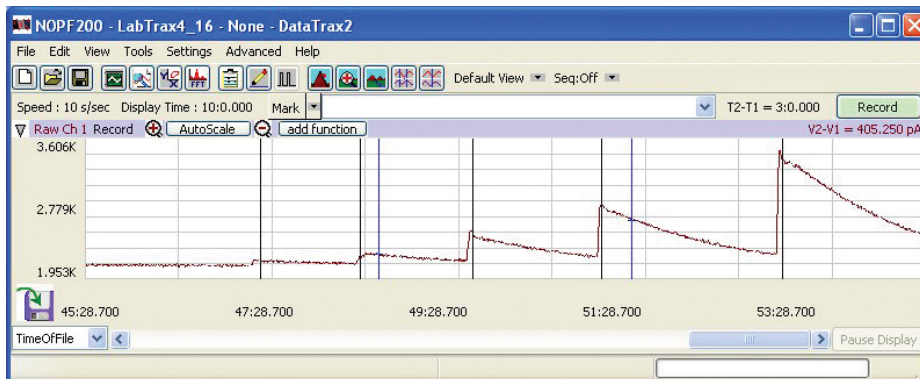

Fig. 44—Raw data for ISO-NOPF200

- Click the **Add Function** button that is located above the channel to be calibrated, and choose **Multipoint Calibration (Right)**. The **Multipoint Units Conversion** dialog box appears (Fig. 45). The data points of interest include the “zero” point and the peaks after each injection of SNAP.

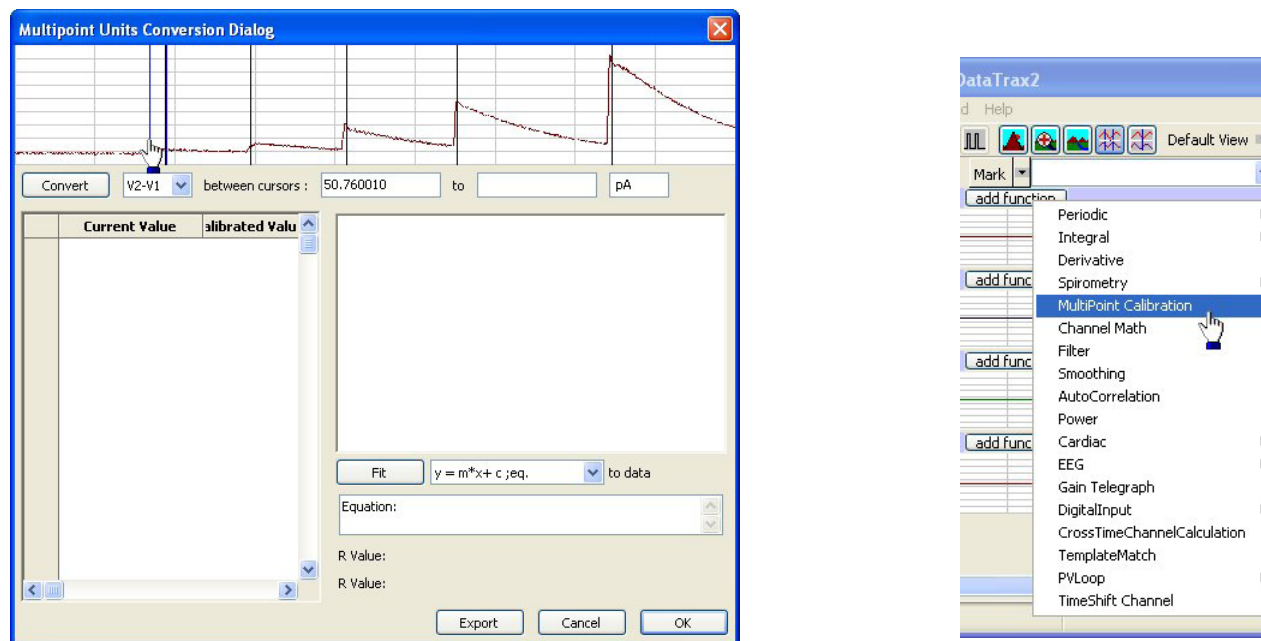

Fig. 45—Multipoint Units Conversion dialog box

- Select the **V2-V1** option from the drop down list located immediately to the right of the **Convert** button. Use V2-V1 because it measures a change in current from one injection to the next.
- Drag the left, vertical blue “cursor” line to the lowest point on the graph before the injection. Then, drag the right “cursor” to the highest point after the injection.
- Calculate the final concentration of SNAP in the solution after the aliquot is injected.

TIP: For a comprehensive discussion of the molarity calculations, see pages 21-22.
- In the second text box, enter the calculated concentration on NO resulting from the injection.
- In the third text box, enter the unit of measure (in this case nM).
- Press the **Convert** button. A value appears on the table found in the bottom left corner of the dialog box.
- Repeat steps 4-8 for each calibration point. In the example, for the 2 μ L injection, the points of measure are just before the mechanical injection of the 2 μ L and the peak of the 2 μ L aliquot. This is repeated for 4, 8, 16 and 32 μ L injections.

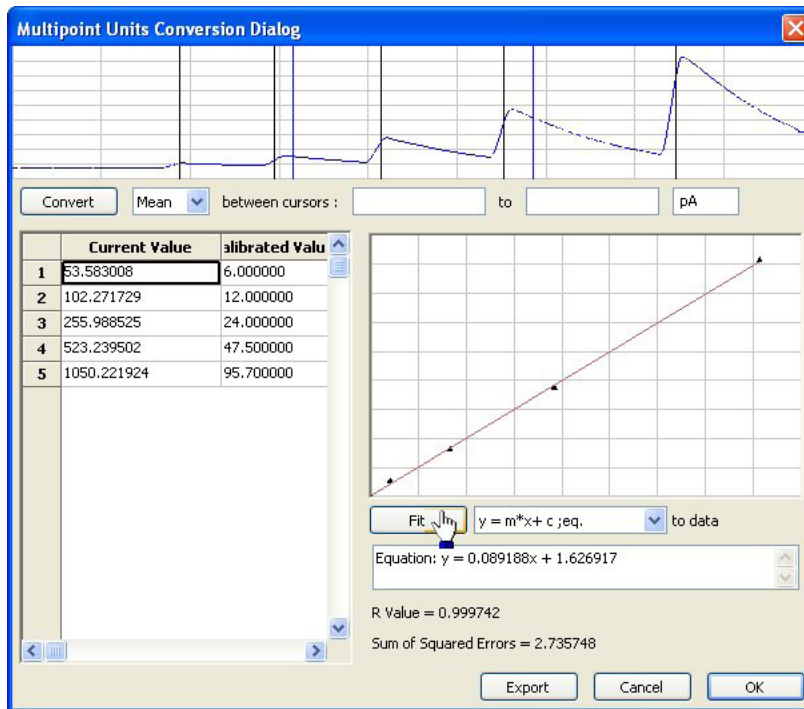

Fig. 46—Multipoint Units Conversion dialog box, with graph

- After all the values have been entered, click the **Fit** button to generate the linear regression equation and its R value. The calculated conversion graph then appears on the right side of the dialog box, and the equation and R value are printed below it. The closer the R value is to one, the greater the accuracy of the calibration (Fig. 46).
- If desired, export the equation to a text file by pressing the **Export** key (Fig. 46).
- The final calibration results appear at the bottom of the recording on the LabScribe main page as a comparison channel (Fig. 47).
- When finished, click the **OK** button.

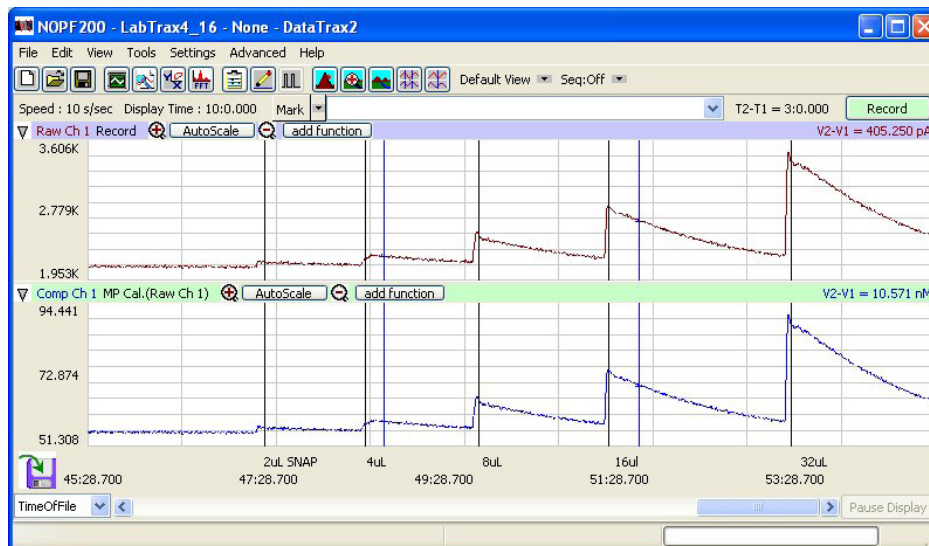

Fig. 47—Raw Data in channel 1, Calibrated data in comparison channel

Filter/Smoothing Data

Figure 45 shows the raw data recording of NO on the **TBR4100** in channel 1 and the calibrated comparison beneath it. If desired, the graph can be filtered or smoothed.

- To filter the data and display it in a separate channel directly below the raw data, click the **Add Function** button on the channel to be filtered and select **Filter (Right)**. The **Filter Setup** dialog box appears (Fig. 48).

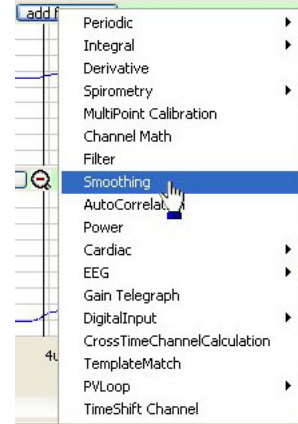
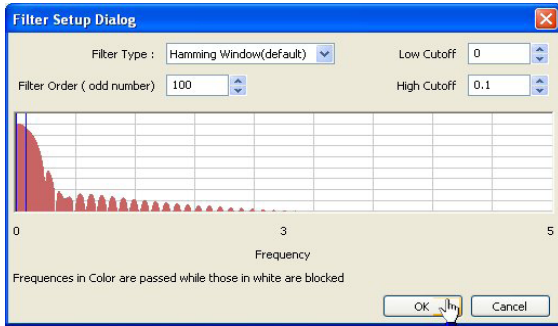

Fig. 48—(Right) Filter Setup dialog box

- Select the appropriate filter from the **Filter Type** drop down list. WPI routinely uses the **Hamming Window** filter.
- Enter the appropriate values. WPI recommends a **Filter Order** of 100, **Low Cutoff** of 0 and a **High Cutoff** of 0.1.

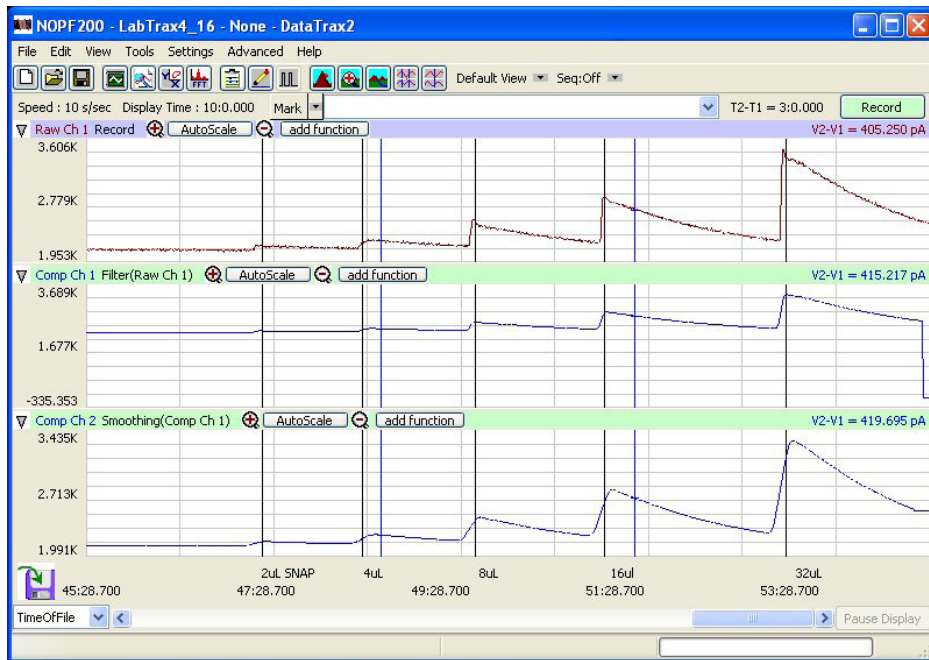

Fig. 49—Raw Data in channel 1, filtered data in first comparison channel (Comp Ch 1), smoothed data in second comparison channel (Comp Ch 2)

- Click the **OK** button. A new comparison channel displays at the bottom of the main LabScribe window. When applied to the raw data in Figure 46, a typical Hamming filter generates a less noisy output trace similar to the raw data in channel (Fig. 49).

5. If desired, additional smoothing can also be added to the filtered data. Click the **Add Function** button of the desired channel and select **Smoothing (Left)**. The **Smoothing** dialog box appears (Fig. 50). WPI often adds a moving average on each side, by selecting **Moving Average Type** drop down list and entering 60 in the field. Click the **OK** button when finished.

Fig. 50—(Right) Smoothing dialog box

TIP: To change the parameters of a function, click configured channel (highlighted region of Fig. 51) to and select **Setup Function**. The function dialog previous settings. Edit the settings, as desired, and click the **OK** button. The changes will display in the channel on the main LabScribe window.

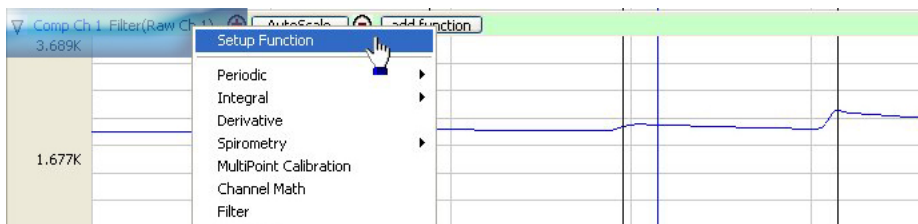

The **Smoothing** dialog average that is 60 points from the **Smoothing Points on each side** text

on the name of the display the popup menu box appears with the

OK button.

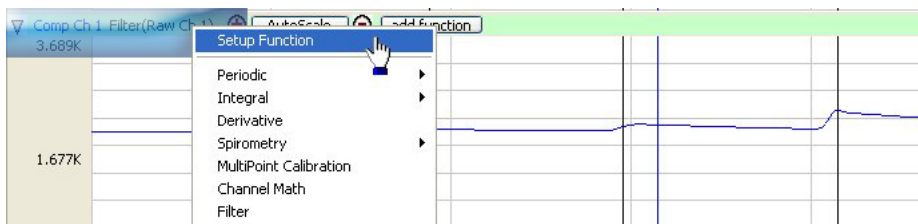

Fig. 51— Edit the function settings of a previously modified channel

Installing the Drivers Manually

If the Lab-Trax unit is inadvertently connected to your computer's USB port *before* installing the LabScribe software, the Windows hardware installation wizard will automatically try to install the drivers. If the install disk is not in the CD-ROM drive, the drivers are unavailable to the hardware wizard. This creates a hardware interface problem which can only be corrected by manually installing the driver. The following procedure may be used to correct the problem.

Usually, disconnecting the Lab-Trax from its USB port and connecting it to a different USB port will bring up the dialog boxes to re-install the drivers. Select "Yes" to continue and complete the driver installation starting with step 7 below. If that is unsuccessful, install the drivers manually. To install the drivers manually:

1. Open the **Device Manager**. In Windows XP, click **Start>Settings>Control Panel** (Fig. 52). The **Control Panel** window appears (Fig. 53).

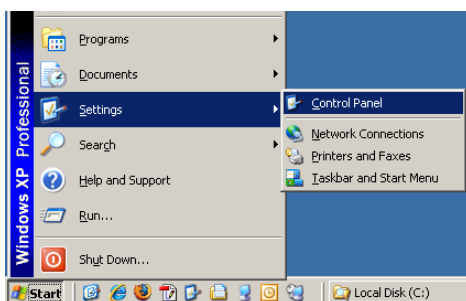

Fig. 52—Windows Start Menu

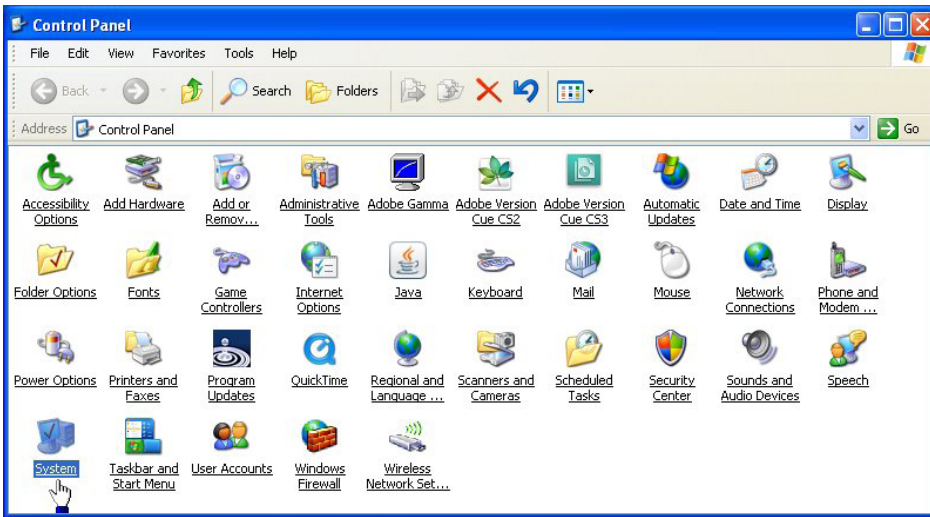

Fig. 53—Control Panel (bottom)

2. Double click on the **System** icon. The **System Properties** dialog box appears (Fig. 54).



Fig. 54—(Left) System Properties, General tab

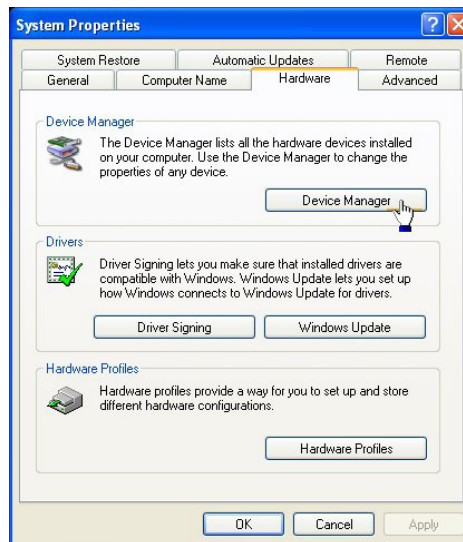

Fig. 55—(Right) System Properties, Hardware tab

3. Choose the **Hardware** tab (Fig. 55).

4. Click the **Device Manager** button. The **Device Manager** window appears (Fig. 56).

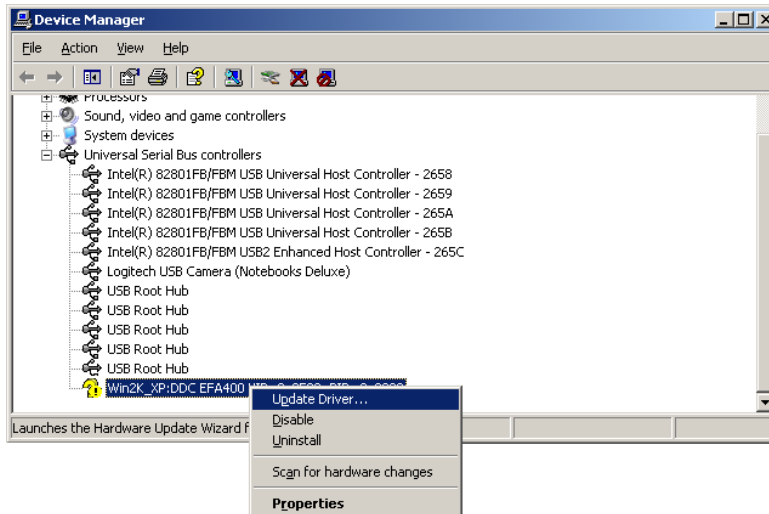

Fig. 56—Device Manager

5. Click on the [+] icon next to Universal Serial Bus Controllers to display the list of USB devices.
6. Right-click the item with a yellow flag (EFA400) and select **Update Driver**. (If you double click the item, the **Properties** dialog box displays, and you can choose the **Drivers** tab. Click the **Update Driver** button.) The Hardware Update Wizard appears (Fig. 57).



Fig. 57—Hardware Update Wizard

NOTE: If the hardware does not appear in the table, select **Action** and **Scan for hardware changes**. If it still does not appear, select another USB port.

7. Select **No not this time** radio button for the Internet driver search, then press the **Next** button. The wizard then offers installation options (Fig. 58).

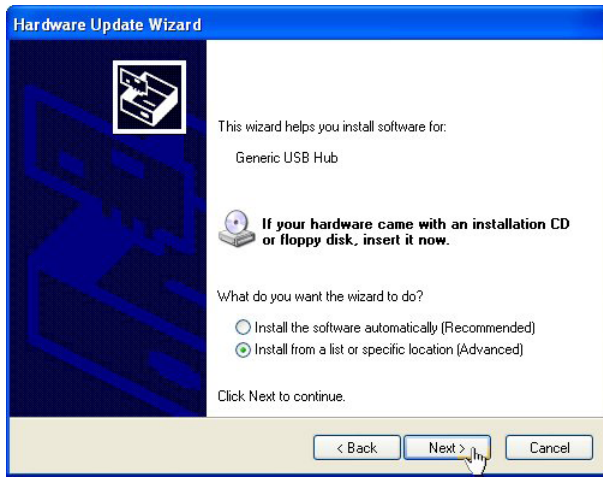

Fig. 58—Install options

8. Select the **Install from a list or specific location** radio button, and click the **Next** button. Then, then wizard asks where to search for the install files (Fig. 59).

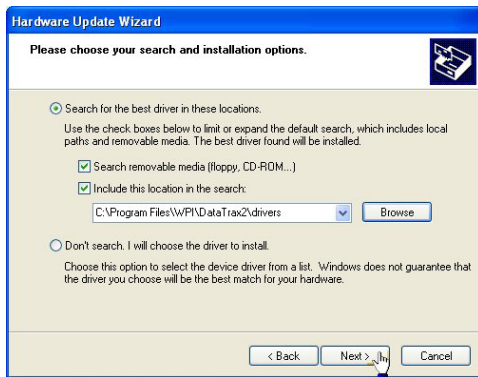

Fig. 59—Search locations

9. Verify that the install disk is in the CD drive. Select the **Search for the best driver in these locations** radio button, and choose the **Search removable media** checkbox and click the **Next** button.

NOTE: If the drivers were copied from the CD during the installation of the software, they can be found on your computer [root]:\Program Files\WPI\LabScribe2\drivers. Select the Browse button to navigate to that location.

10. Follow the instructions on the **Setup Wizard** to complete the installation.

INDEX

Symbols

7364 8, 28, 31

A

activity coefficient 25, 26
 amperometric sensors 6
 amplifier 6
 anaerobic environment 16
 aqueous calibration 24
 argon 11, 12, 14, 19, 20
 atmospheric pressure 24, 25

B

blood 25, 26
 Bunsen coefficients 37

C

calibration curve 12, 14, 15, 16, 17,
 18, 22, 24, 25
 catalyst 10, 13, 14, 15, 16
 Cidex 8, 28, 31
 conversion efficiency 14, 17
 CuCl 10, 14, 15
 CuCl₂ 10, 14, 15, 17, 51
 cupric chloride 14
 cuprous chloride 14, 15

D

data acquisition 6, 41, 46
 Device Manager 55
 display time 48
 dissolved oxygen calibration 24
 drift 14
 driver selection 44
 durability 8, 30

E

effective concentration 17, 25
 electrical interference 29
 electrode 7
 EMI 6
 environmental influences 29
 enzymatic detergent 8, 31

F

Faraday cage 6
 filling solution 29
 filter 7
 filter data 54
 fume hood 19

G

gravimetric 18
 ground 30
 grounding 6

H

H₂O₂ 21, 22, 38, 39
 H₂SO₄ 10, 11
 Hamming 54

handling 8, 30
 HCl 8, 31
 HPO sensor 21
 hydrogen peroxide 4, 21

I

input connectors 4
 ion chromatography 11
 ISO-COP 28, 31
 ISO-HPO-2 21, 22, 38
 ISO-HPO-100 38
 ISO-NOP 10, 11, 15, 20, 38
 ISO-NOP007 38
 ISO-NOPF 38
 ISO-NOPNM 38
 ISO-OXY-2 23, 25, 38

K

Kimwipes 8, 9, 30
 kinetic studies 7
 KNO₂ 11, 12
 KOH 19, 20

L

LabScribe 7, 15, 16, 41, 46, 55
 configure 46
 install 41
 launch 45
 License Agreement 41
 reinstall 55
 voltmeter 50
 LabTrax 43
 driver selection 44
 LEMO 4
 linear regression 18
 living tissue 25
 locking cap 7

M

membrane 7
 membrane, cleaning 8, 31
 membrane sleeve, replacement 9
 MF28G67-5 9
 MicroFil 9
 MiVi = MfVf 17
 M = m/V 17
 multipoint calibration 50
 Multipoint Units Conversion 52

N

NaOH 8, 31
 nitric oxide 18
 nitric oxide microsensors 20
 nitric oxide sensor 10
 nitrogen 12, 14, 19, 20, 23
 NO delivery 20
 NO, environmental influences 20
 NO gas 10, 17, 19, 20
 noise 6

NO measurement 20
 NO microsensors, storage 21
 NO sensor calibration 10
 NO sensors maintenance 20

O

O₂ 23, 24, 25, 26, 38
 organic solvents 29
 output module 6
 oxygen calibration 24
 oxygen sensor 23, 24
 oxygen solubility vs. altitude 37

P

parts list 2
 PBS buffer 21, 22, 39
 plasma 37
 platinum cathode 23
 polarize 7, 10, 11, 14, 21, 29
 polymer tubing 19
 Preferences Dialog 47
 prescaling 48
 probe handle 7
 probe select 4
 protease 8, 31
 pulmonary edema 18

Q

quiescent baseline 12

R

range 4
 redox current 16
 replacement membrane 29
 research mode 45, 50
 returns 3

S

saline solution 9, 11
 sampling rate 47
 saturated water-vapor vs. partial
 pressure in mmHg 37
 scatter plot 18
 shield 30
 shielding 6
 Simple Units Conversion 48
 sleeve 7
 smoothing 55
 SNAP 10, 13, 14, 15, 16, 17, 18, 51,
 52
 SNAP Solution 39
 solubility of oxygen in fresh water 35
 solubility of oxygen in seawater 36
 standard solutions 39
 startup kit 29
 static 6
 sterilize 8, 28, 31
 stoichiometry 11
 stop flow 7

TBR4100/1025

storage 21, 23, 26
store 28, 29, 31

T

teaching mode 45, 50
temperature 29, 30
temperature input 33
two-point calibration 48
Tygon 19

U

unpacking 3
update driver 57

V

voltmeter 50

W

water-saturated air 25

DECLARATION OF CONFORMITY



WORLD PRECISION INSTRUMENTS, LLC.
Telephone: (941) 371-1003 Fax: (941) 377-5428
e-mail wpi@wpiinc.com

DECLARATION OF CONFORMITY CE

We: World Precision Instruments, Inc.
175 Sarasota Center Boulevard
Sarasota, FL 34240-9258, USA

as the manufacturer/distributor of the apparatus listed, declare under sole responsibility that the product(s):

TBR4100

To which this declaration relates is/are in conformity with the following standards or other normative documents:

Low Voltage Directive (Safety) 2014/35/EU:

- EN 61010-1:2010+A1:2019

EMC Directive 2014/30/EU:

- EN IEC 61326-1:2021
- EN IEC 61326-2-3:2021
- EN IEC 61000-3-2:2019+A1:2021
- EN IEC 61000-3-3:2013+A2:2021

Issued On: December 13, 2022

Cory Boyes / Director of Design and
Development

Europe Representative
Mr Andrew Waldes
Managing Director
World Precision Instruments Germany GmbH,
Pfungstweide 16, 61169 Friedberg, Germany

F-QC-006 Rev D



WORLD PRECISION INSTRUMENTS, LLC.
Telephone: (941) 371-1003 Fax: (941) 377-5428
e-mail wpi@wpiinc.com

DECLARATION OF CONFORMITY CE

We: World Precision Instruments, Inc.
175 Sarasota Center Boulevard
Sarasota, FL 34240-9258, USA

as the manufacturer/distributor of the apparatus listed, declare under sole responsibility that the product(s):

TBR1025

To which this declaration relates is/are in conformity with the following standards or other normative documents:

Low Voltage Directive (Safety) 2014/35/EU:

- EN 61010-1:2010+A1:2019

EMC Directive 2014/30/EU:

- EN IEC 61326-1:2021
- EN IEC 61326-2-3:2021
- EN IEC 61000-3-2:2019+A1:2021
- EN IEC 61000-3-3:2013+A2:2021

Issued On: December 13, 2022

Cory Boyes / Director of Design and
Development

Europe Representative
Mr Andrew Waldes
Managing Director
World Precision Instruments Germany GmbH,
Pfungstweide 16, 61169 Friedberg, Germany

WARRANTY

WPI (World Precision Instruments) warrants to the original purchaser that this equipment, including its components and parts, shall be free from defects in material and workmanship for a period of one year* from the date of receipt. WPI's obligation under this warranty shall be limited to repair or replacement, at WPI's option, of the equipment or defective components or parts upon receipt thereof f.o.b. WPI, Sarasota, Florida U.S.A. Return of a repaired instrument shall be f.o.b. Sarasota.

The above warranty is contingent upon normal usage and does not cover products which have been modified without WPI's approval or which have been subjected to unusual physical or electrical stress or on which the original identification marks have been removed or altered. The above warranty will not apply if adjustment, repair or parts replacement is required because of accident, neglect, misuse, failure of electric power, air conditioning, humidity control, or causes other than normal and ordinary usage.

To the extent that any of its equipment is furnished by a manufacturer other than WPI, the foregoing warranty shall be applicable only to the extent of the warranty furnished by such other manufacturer. This warranty will not apply to appearance terms, such as knobs, handles, dials or the like.

WPI makes no warranty of any kind, express or implied or statutory, including without limitation any warranties of merchantability and/or fitness for a particular purpose. WPI shall not be liable for any damages, whether direct, indirect, special or consequential arising from a failure of this product to operate in the manner desired by the user. WPI shall not be liable for any damage to data or property that may be caused directly or indirectly by use of this product.

Claims and Returns

- Inspect all shipments upon receipt. Missing cartons or obvious damage to cartons should be noted on the delivery receipt before signing. Concealed loss or damage should be reported at once to the carrier and an inspection requested. All claims for shortage or damage must be made within 10 days after receipt of shipment. Claims for lost shipments must be made within 30 days of invoice or other notification of shipment. Please save damaged or pilfered cartons until claim settles. In some instances, photographic documentation may be required. Some items are time sensitive; WPI assumes no extended warranty or any liability for use beyond the date specified on the container.
- WPI cannot be held responsible for items damaged in shipment en route to us. Please enclose merchandise in its original shipping container to avoid damage from handling. We recommend that you insure merchandise when shipping. The customer is responsible for paying shipping expenses including adequate insurance on all items returned.
- Do not return any goods to WPI without obtaining prior approval and instructions (RMA#) from our returns department. Goods returned unauthorized or by collect freight may be refused. The RMA# must be clearly displayed on the outside of the box, or the package will not be accepted. Please contact the RMA department for a request form.
- Goods returned for repair must be reasonably clean and free of hazardous materials.
- A handling fee is charged for goods returned for exchange or credit. This fee may add up to 25% of the sale price depending on the condition of the item. Goods ordered in error are also subject to the handling fee.
- Equipment which was built as a special order cannot be returned.
- Always refer to the RMA# when contacting WPI to obtain a status of your returned item.
- For any other issues regarding a claim or return, please contact the RMA department

Warning: This equipment is not designed or intended for use on humans.

* Electrodes, batteries and other consumable parts are warranted for 30 days only from the date on which the customer receives these items.

USA

175 Sarasota Center Blvd., Sarasota FL 34240-9258
Tel: 941-371-1003 • Fax: 941-377-5428 • E-mail: sales@wpiinc.com

UK

1 Hunting Gate, Hitchin, Hertfordshire SG4 0TJ
Tel: 44 (0)1462 424700 • Fax: 44 (0)1462 424701 • E-mail: wpiuk@wpi-europe.com

Germany

Pfingstweide 16, D-61169 Friedberg (Hessen), Germany
Tel: +49 (0)6031 67708-0 • Fax: +49 (0)6031 67708-80 • E-mail: wpide@wpi-europe.com

China & Hong Kong

WPI Shanghai Trading Co., Ltd. Rm 2608
Tongmao Mansion, No 357, Songlin Road, Pudong New District, Shanghai, PR China
Tel: +86 21 6888 5517 • Toll Free: 400 688 5517 • E-mail: chinasales@china.wpiinc.com

Internet

www.wpiinc.com • www.wpi-europe.com • www.wpiinc.net